

2023

Comfortex
WINDOW FASHIONS

Distributed by:

MDS Midwest
WINDOW FASHIONS Designer
Supply

1-888-523-2611



COLOR LUX[®] CELLULAR SHADES

Manufacturer's Price List and Reference Guide

Effective April 17, 2023



Detailed Table of Contents



Hardware



Photos



Price Grids



Videos



Product Specifications



Installation



General Information



Web



 Requires you to leave document

Color Lux Cellular Price List - Effective 04.17.2023

Version 1	Original Price List Effective April 17, 2023	Uploaded 03/17/2023
-----------	--	---------------------



Hardware Options



Size Standards



Hardware Options Pricing



COLOR LUX SIMPLICITY BLUETOOTH MOTORS QUIETUDE™ TECHNOLOGY

Color Lux Simplicity Bluetooth motors now feature our exclusive Quietude™ technology. Our Quietude™ technology significantly reduces motor running noise, and delivers both performance and a user-friendly customer experience.

Color lux Simplicity Bluetooth motors, with Radio-Frequency, Bluetooth and SmartHub control options, are now one of the quietest and most completely versatile offerings in the industry.

Quietude™ technology enables shades to operate at the same speed, so all shades perform consistently. The operating speeds can also be adjusted using our Color Lux Mobile app.

Color Lux Simplicity Bluetooth motors now also communicate daily with other Quietude™ motors in the proximity in order to synchronize schedules, as set in the Color Lux Mobile app.







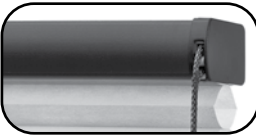

Scotchgard™ Protection

Optional Scotchgard™ Protector is available with all Color Lux fabrics. Scotchgard™ keeps your shades looking newer, fresher and cleaner longer.

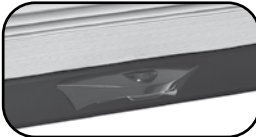



A combination of the latest advances in stain release and repellency provides exceptional stain protection. Spills wipe away easily and most dirt and stains lift out when cleaned.

Color Lux® Cellular Shades
HARDWARE OPTIONS

	Key Features	Hardware Options	Hardware Size (Depth x Height)	Shade Size Available*	More Information
<p>Standard Cord Lock</p> 	<ul style="list-style-type: none"> • Proven cord lock • Sleek, fabric wrapped rails • UV resistant cords 	<ul style="list-style-type: none"> • Fabric Wrapped • Oil Rubbed Bronze 	2 ³ / ₈ " x 1/2"	<p>Width: 8" to 108"</p> <p>Length: 8" to 120"</p>	Page 23
<p>Cord Loop</p> 	<ul style="list-style-type: none"> • Cord Loop makes operation easy • Smooth & quiet operation 	<ul style="list-style-type: none"> • Fabric Wrapped • Oil Rubbed Bronze 	2 ¹ / ₄ " x 1 ¹ / ₂ "	<p>Width: 14" to 108"</p> <p>Length: 8" to 120"</p>	Page 25
<p>Cordless Ultra</p> 	<ul style="list-style-type: none"> • Child safe • No visible cords • Smooth & quiet operation 	<ul style="list-style-type: none"> • Fabric Wrapped • Oil Rubbed Bronze 	2 ¹ / ₄ " x 1 ¹ / ₂ "	<p>Width: 15" to 108"</p> <p>Length: 8" to 84"</p>	Page 27
<p>Cordless Lift & Lock</p> 	<ul style="list-style-type: none"> • Child safe • Easy push button operation • Rails lock securely in place in any position 	<ul style="list-style-type: none"> • Fabric Wrapped • Oil Rubbed Bronze 	<p>2³/₈" x 1/2"</p> <p>Bottom Rail: 1⁷/₈" x 1¹/₈"</p>	<p>Width: 16" to 96"</p> <p>Length: 8" to 84"</p>	Page 29
<p>12V Non-Rechargeable Simplicity Motorization</p> 	<ul style="list-style-type: none"> • Raise & lower shade with click of a button • Great for large and hard to reach windows • Remote can operate multiple shades 	<ul style="list-style-type: none"> • Fabric Wrapped • Oil Rubbed Bronze 	2 ¹ / ₄ " x 1 ¹ / ₂ "	<p>Width: 18" to 108"</p> <p>Length: 8" to 120"</p>	Page 32
<p>7.4V Rechargeable Simplicity Motorization with Quietude™ Technology</p> 	<ul style="list-style-type: none"> • Features a battery powered motor utilizing a rechargeable battery pack • Raise & lower shade with click of a button • Great for large and hard to reach windows • Remote can operate multiple shades 	<ul style="list-style-type: none"> • Fabric Wrapped • Oil Rubbed Bronze 	2 ¹ / ₄ " x 1 ¹ / ₂ "	<p>Width: 18" to 108"</p> <p>Length: 8" to 120"</p>	Page 34
<p>7.4V Rechargeable PowerTouch</p> 	<ul style="list-style-type: none"> • Raise & lower shade with push of a button • Eliminate the need to stand by the shade to operate; just touch and go • Favorite position button • Rechargeable battery pack with recharge port on pendant 	<ul style="list-style-type: none"> • Wand and pendant available in white or black 	2 ¹ / ₄ " x 1 ¹ / ₂ "	<p>Width: 18" to 108"</p> <p>Length: 8" to 120"</p>	Page 44
<p>Ovation™ Slider</p> 	<ul style="list-style-type: none"> • Vertically oriented fabric glides across window • Shade can stack left, right or center • Great for sliding glass doors or room dividers 	<ul style="list-style-type: none"> • White (Standard) • Ivory • Tan • Gray 	3 ⁵ / ₈ " x 1 ³ / ₄ "	<p>Width: 12" to 168"</p> <p>Length: 24" to 108"</p>	Page 47

* Maximum widths and lengths listed do not take into account square foot or weight limitations. Make sure to refer to shaded areas on price groups for maximum size availability by fabric style.

Color Lux® Cellular Shades
HARDWARE OPTIONS

	Key Features	Color Options	Hardware Size (Depth x Height)	Shade Size Available*	More Information
<p>Door Décor</p> 	<ul style="list-style-type: none"> • Great option for narrow windows and doors • Available in movable & non-movable rails • No Pull cords 	<ul style="list-style-type: none"> • Fabric Wrapped • Oil Rubbed Bronze 	2 3/8" x 1/2"	<p>Width: 3" to 36"</p> <p>Length: 12" to 96"</p>	Page 69
<p>Top Down-Bottom Up</p> 	<ul style="list-style-type: none"> • Lower shade from top: raise from bottom • Great for privacy • Ideal for light control • Motorization Available 	<ul style="list-style-type: none"> • Fabric Wrapped • Oil Rubbed Bronze 	2 3/8" x 1/2"	<p>Width: 18" to 108"</p> <p>Length: 8" to 120"</p>	See Product Availability Page 23-31
<p>Two on One Head Rail</p> 	<ul style="list-style-type: none"> • Operate two shades on one rail • Great for larger windows • Individually operating shades 	<ul style="list-style-type: none"> • Fabric Wrapped • Oil Rubbed Bronze 	Dependent on Hardware Chosen See Above	<p>Width: 16" to 144"</p> <p>Length: 8" to 120"</p>	See Product Availability Page 24-31
<p>Insulating SlumberShade™</p> 	<ul style="list-style-type: none"> • Ultimate blackout shade • Tracks keep out light, cold or heat • Perfect for nurseries, day sleepers • Available in Cord Lock, Cord Loop, Cordless and motorized • Note: Not available on Boutique fabrics 	<ul style="list-style-type: none"> • Fabric Wrapped • Oil Rubbed Bronze • Sidetracks are available in white, tan or bronze 	Dependent on hardware choice	<p>Width: 9" to 96"</p> <p>Length: 8" to 120"</p>	Page 51

* Maximum widths and lengths listed do not take into account square foot or weight limitations. Make sure to refer to shaded areas on price groups for maximum size availability by fabric style.

Color Lux Cellular Shade Collection
FABRIC COLLECTIONS

Fabric Collection	Cell Size and Structure	Opacities	Fabric Content
Boutique	<ul style="list-style-type: none"> • ¾ -Inch • Single Cell 	<ul style="list-style-type: none"> • Light Filtering • Karma-Light Room Darkening 	<ul style="list-style-type: none"> • Light Filtering: Non-Woven Polyester • Room Darkening: Opaque lining pressed between two layers of non-woven polyester • Karma-Light technology insures color on front fabric will not be distorted like traditional blackout shades. Opaque lining is used only on back side of the cells
Linen Weave	<ul style="list-style-type: none"> • ¾ -Inch • Single Cell 	<ul style="list-style-type: none"> • Light Filtering • Karma-Light Room Darkening 	<ul style="list-style-type: none"> • Light Filtering: Non-Woven Polyester • Karma-Light technology insures color on front fabric will not be distorted like traditional blackout shades.
Aspen	<ul style="list-style-type: none"> • ¾-Inch • Double Cell 	<ul style="list-style-type: none"> • Light Filtering 	<ul style="list-style-type: none"> • Light Filtering: Non-Woven Polyester
Verona Textures	<ul style="list-style-type: none"> • ¾ Inch • Single Cell 	<ul style="list-style-type: none"> • Light Filtering • Karma-Light Room Darkening 	<ul style="list-style-type: none"> • Light Filtering: Non-Woven Polyester • Room Darkening: Opaque lining pressed between two layers of non-woven polyester • Karma-Light technology insures color on front fabric will not be distorted like traditional blackout shades. Opaque lining is used only on back side of the cells

Color Lux® Cellular Shades

SIZE STANDARDS

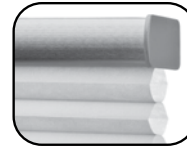
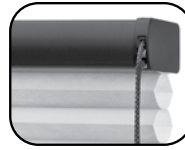
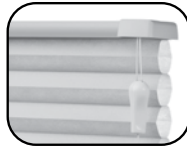

				Cord Lock		Cord Loop		Cordless Ultra		Cordless Lift & Lock	
				Standard	TD-BU	Standard	TD-BU+	Standard	TD-BU+	Standard	TD-BU
Minimum											
COLOR LUX® FABRICS			Min. Width	8"	12"	14"	22"	15" OB 15 ³ / ₈ " IB	18" OB 18 ³ / ₈ " IB	16" OB 16 ³ / ₈ " IB	20" OB 20 ³ / ₈ " IB
			Min. Length	8"	8"	8"	8"	8"	8"	8"	8"
				Cord Lock		Cord Loop		Cordless Ultra		Cordless Lift & Lock	
				Standard	TD-BU	Standard	TD-BU+	Standard	TD-BU+	Standard	TD-BU
Linen Weave, Aspen LF, Verona Textures & Boutique			Price Group								
			Page								
Light Filtering	1 3	11 13	Maximum Width & Length	108" width 120" length	96" width 96" length	108" width 120" length	108" width 120" length	108" width 84" length	96" width 84" length	96" width 84" length	96" width 84" length
Room Darkening <i>Excluding Aspen</i>	2	12	Maximum Width & Length	108" width 120" length	84" width 96" length	108" width 120" length	108" width 120" length	108" width 84" length	96" width 84" length	96" width 84" length	96" width 84" length
				Cord Lock		Cord Loop		Cordless Ultra		Cordless Lift & Lock	
				Standard	TD-BU	Standard	TD-BU+	Standard	TD-BU+	Standard	TD-BU
Stacking Heights Information On Page More Information On Page				Page 8 Page 25		Page 8 Page 27		Page 8 Page 29		Page 8 Page 31	

+ Maximum Width & Length and Minimum Width & Length applies to StrataView Shades



				Motorization		Motorized PowerTouch		Two-On-One Head Rail		Ovation
				Simplicity+	Rechargeable	Cord Lock*	Cord Loop/Cordless**	Standard		
Minimum										
COLOR LUX® FABRICS			Minimum Width	18" OB 18 ³ / ₈ " IB	18" OB 18 ³ / ₈ " IB	16"	36"	12"		
			Min. Length	8"	8"	8"	8"	24"		
				Motorization		Motorization		Two-On-One Head Rail		Ovation
				Simplicity~	PowerTouch	Cord Lock*	Cord Loop/Cordless**	Standard		
Linen Weave, Aspen LF, Verona Textures & Boutique										
Light Filtering			Maximum Width & Length	108" width 120" length	108" width 120" length	144" width 120" length	144" width 120" length	120" width*** 108" length		
Room Darkening <i>Excluding Aspen</i>			Maximum Width & Length	108" width 120" length	108" width 120" length	144" width 120" length	144" width 120" length	120" width*** 108" length		
				Motorization		Motorization		Two-On-One Head Rail		Ovation
				Simplicity	PowerTouch	Cord Lock	Cord Loop/Cordless	Standard		
Stacking Heights Information On Page More Information On Page				Page 9 Page 37-46		Page 9 Page 42-45		Page 9 Page 25-38		Page 9 Page 47

Motorized shades less than 24" in width are limited to a maximum of 60" in length. Cordloop and cordless shades less than 24" in width are limited to 84" in length.

Maximum widths and lengths listed do not take into account square foot or weight limitations. Make sure to refer to shaded areas on price groups for maximum size availability by fabric style. * Minimum single panel is 8", maximum single panel is 108". ** Minimum single panel is 18", maximum single panel is 108". *** Split stack sliders are available 240", however if the width exceeds 120", the shade will be fabricated as two separate sliders. Supplied valance will create the appearance of a single slider. + Minimum for Motorized Top Down-Bottom Up is 24" IB and 23³/₈" OB. Minimum length and maximum length and width are the same as Simplicity motorization specs.

Color Lux® Cellular Shades

SIZE STANDARDS



		SlumberShade Cord Lock		SlumberShade Cord Loop		SlumberShade Cordless		Motorization
		Bottom Up	Top Down Bottom Up	Bottom Up	Top Down Bottom Up	Bottom Up	Top Down Bottom Up	7.4V Simplicity Rechargeable
LINEN WEAVE FABRICS (not available in Boutique fabrics)	Minimum Width	9"	13"	15"	23"	16 $\frac{3}{8}$ " IB	19 $\frac{3}{8}$ " IB	19 $\frac{3}{8}$ "
	Min. Length	8"	8"	8"	8"	8"	8"	8"

			SlumberShade Cord Lock		SlumberShade Cord Loop		SlumberShade Cordless		Motorization	
			Bottom Up	Top Down Bottom Up	Bottom Up	Top Down Bottom Up	Bottom Up	Top Down Bottom Up	7.4V Simplicity Rechargeable	
Light Filtering	Price Group	Page								
Linen Weave Verona Textures Aspen	1	11	Maximum Width & Length							
	3	13	Refer to shaded area in price grids for max size (sq ft) by fabric style		96" width 120" length	96" width 96" length	96" width 120" length	96" width 120" length	96" width 84" length	96" width 84" length

			SlumberShade Cord Lock		SlumberShade Cord Loop		SlumberShade Cordless		Motorization	
			Bottom Up	Top Down Bottom Up	Bottom Up	Top Down Bottom Up	Bottom Up	Top Down Bottom Up	7.4V Simplicity Rechargeable	
Room Darkening & Blackout	Price Group	Page								
Linen Weave Verona Textures	2	12	Maximum Width & Length							
	4	13	Refer to shaded area in price grids for max size (sq ft) by fabric style		96" width 120" length	84" width 96" length	96" width 120" length	96" width 120" length	96" width 84" length	96" width 84" length

			SlumberShade Cord Lock		SlumberShade Cord Loop		SlumberShade Cordless		Motorization
			Bottom Up	Top Down Bottom Up	Bottom Up	Top Down Bottom Up	Bottom Up	Top Down Bottom Up	7.4V Simplicity Rechargeable
Stacking Heights Information On Page More Information On Page			Page 8 Page 49-50		Page 8 Page 49-50		Page 8 Page 49-50		Page 8 Page 49-50

Color Lux® Cellular Shades

SIZE STANDARDS

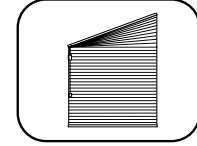
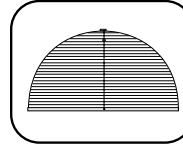
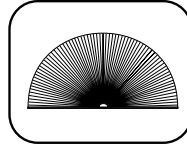

		Starburst Arch		Sunset Arch	Mezzo Skylight	Trapezoid
		Non-Movable/Movable	Movable	Motorized	Standard	
COLOR LUX® FABRICS	Minimum					
	Min. Width	18"	18"	18"	12"	
	Min. Length	9"	6"	12"	12"	
Linen Weave, Aspen LF, Verona Textures & Boutique		Starburst Arch		Sunset Arch	Mezzo Skylight	Trapezoid
		Non-Movable/Movable	Movable	Motorized	Standard	
Light Filtering	Maximum Width & Length	72" x 36"	72" x 60"	48" x 72"	48" x 72"*	
Room Darkening	Maximum Width & Length	72" x 36"	60" x 60"	48" x 72"	48" x 72"	
		Starburst Arch		Sunset Arch	Mezzo Skylight	Trapezoid
		Non-Movable/Movable	Movable	Motorized	Standard	
Stacking Heights Information On Page More Information On Page		Page 8 Page 53	Page 8 Page 56	Page 8 Page 60	Page 8 Page 58	

*Max width of trapezoid refers to width of top rail.

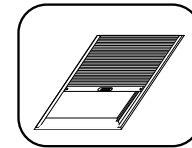
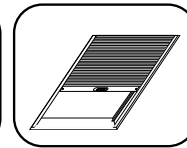
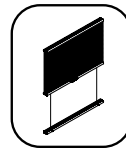
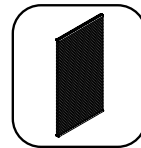
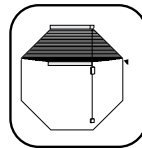

		Octagon	French Door Décor		Soprano Greenhouse		Balcony Skylights
		Standard	Non-Movable	Movable	Movable		Movable
COLOR LUX® FABRICS <i>(Greenhouse Aspen Only)</i>	Minimum						
	Minimum Width	12"	6"	6"	6"	6"	15"
	Min. Length	12"	12"	12"	12"	12"	12"
Linen Weave, Aspen LF, Verona Textures & Boutique		Octagon	French Door Décor		Soprano Greenhouse		Balcony Skylights
		Standard	Non-Movable	Movable	Movable		Movable
Light Filtering <i>(Greenhouse Aspen Only)</i>	Maximum Width & Length	48" width 48" length	36" width 96" length	36" width 96" length	48" width 72" length	36" 180"	48" width 96" length Max Sq feet 24'
Room Darkening	Maximum Width & Length	48" width 48" length	36" width 96" length	36" width 96" length	48" width 72" length	NA NA	48" width 96" length Max Sq feet 24'
		Octagon	French Door Décor		Soprano Greenhouse		Balcony Skylights
		Standard	Non-Movable	Movable	Movable		Movable
Stacking Heights Information On Page More Information On Page		Page 8 Page 58	Page 8 Page 67	Page 8 Page 67	Page 8 Page 63		Page 8 Page 65

Color Lux® Cellular Shades

HARDWARE OPTION AVAILABILITY

Use this table to ensure your coordinating options and unique shapes are consistent with your product selections.

	Verona ¾" LF & RD	Boutique ¾" LF & RD	Linen Weave ¾" LF & RD	Aspen ¾" Light Filtering
STANDARD CORD LOCK				
Standard Cord Lock	•	•	•	•
Top Down-Bottom Up	•	•	•	•
Two-On-One Head Rail	•	•	•	•
Day-Night	•	•	•	•
CORD LOOP				
Cord Loop	•	•	•	•
Cord Loop Top Down-Bottom Up	•	•	•	•
Cord Loop Two-On-One Head Rail	•	•	•	•
CORDLESS ULTRA				
Cordless Ultra	•	•	•	•
Cordless Two-On-One Head Rail	•	•	•	•
Cordless Ultra Top Down-Bottom Up	•	•	•	•
CORDLESS LIFT & LOCK				
Cordless Lift & Lock	•	•	•	•
Cordless Lift & Lock Two-On-One Head Rail	•	•	•	•
Cordless Lift & Lock Top Down-Bottom Up	•	•	•	•
MOTORIZATION				
Simplicity Motorization	•	•	•	•
Simplicity Rechargeable Motorization	•	•	•	•
PowerTouch™ Rechargeable	•	•	•	•
Top Down-Bottom Up	•	•	•	•
INSULATING SLUMBERSHADES				
Cord Lock	•	-	•	•
Cord Lock Top Down-Bottom Up	•	-	•	•
Cordless Ultra	•	-	•	•
Cordless Ultra Top Down-Bottom Up	•	-	•	•
Cord Loop	•	-	•	•
Cord Loop Top Down-Bottom Up	•	-	•	•
Simplicity Motorization	•	•	•	•
Simplicity Rechargeable Motorization	•	•	•	•
SKYLIGHTS AND SPECIALTY SHAPES				
Balcony Shading System	•	•	•	•
French Door Decor	•	•	•	•
Mezzo Motorized Skylights	•	•	•	•
Octagon	•	•	•	•
Ovation Cellular Slider	•	•	•	•
Quarter Round - Moveable	•	•	•	•
Quarter Round - Non-Movable	•	•	•	•
Soprano Skylights	•	•	•	•
Soprano Greenhouses	-	-	-	•
Starburst Arch - Movable	•	•	•	•
Starburst Arch - Non-Movable	•	•	•	•
Sunset Arch - Moveable	•	•	•	•
Trapezoid	•	•	•	•

Color Lux StrataView Cellular Shade Pricing Examples

StrataView Cordless Pricing Example: (One sheer panel)

Linen Weave	
Light Filtering 36" x 60" Shade:	\$559.00
StrataView Surcharge:	\$444.00
Total List Price:	\$1,003.00

StrataView Cordless Pricing Example: (Two Color Lux Panels - no sheer)

Linen Weave	
Light Filtering 36" x 60" Panel:	\$559.00
Room Darkening 36" x 60" Panel:	\$726.00
Top Down-Bottom Up Surcharge:	\$85.00
Cordless Surcharge:	\$108.00
Total List Price:	\$1,478.00

StrataView Motorization Pricing Example:

Linen Weave	
Light Filtering 42" x 60" Shade:	\$611.00
Charger for Rechargeable:	\$30.00
StrataView Surcharge:	\$675.00
TDBU Remote Control**:	\$50.00
Total List Price:	\$1,366.00

** TDBU Remote required for Motorized Top Down-Bottom Up shades

SIMPLICITY RECHARGEABLE BATTERY WAND PRICING EXAMPLE:

Linen Weave	
Light Filtering 42" x 60" Shade:	\$611.00
Simplicity Rechargeable Surcharge:	\$300.00
Charger for Rechargeable :	\$30.00
14 Channel Control:	\$50.00
Total List Price:	\$991.00

Color Lux® Cellular Shades

SHADE STACK HEIGHTS

Measurements are in inches. Shade stacking heights applicable when the shade is in the fully raised position.

RECTANGULAR CORD LOCK - Includes head and bottom rails	48"	72"	84"	96"
Linen Weave, Aspen*, Verona Textures & Boutique Light Filtering and Room Darkening Fabrics	2"	2 $\frac{3}{8}$ "	2 $\frac{3}{8}$ "	2 $\frac{3}{8}$ "

For Top Down-Bottom Up, add $\frac{3}{8}$ " | *Aspen available in light filtering only

CORD LOOP - CORDLESS ULTRA - MOTORIZATION - Includes head and bottom rails	48"	72"	84"	96"
Linen Weave, Aspen*, Verona Textures & Boutique Light Filtering and Room Darkening Fabrics	3"	3 $\frac{3}{8}$ "	3 $\frac{3}{8}$ "	3 $\frac{3}{8}$ "
StrataView™	4 $\frac{3}{8}$ "	5 $\frac{1}{2}$ "	6"	6 $\frac{1}{2}$ "

*Aspen available in light filtering only

CORDLESS LIFT & LOCK - Includes head and bottom rails	48"	60"	72"	84"
Linen Weave, Aspen*, Verona Textures & Boutique Light Filtering and Room Darkening Fabrics	2 $\frac{3}{4}$ "	3 $\frac{1}{8}$ "	3 $\frac{3}{8}$ "	3 $\frac{3}{8}$ "

For Top Down-Bottom Up, add 1 $\frac{1}{4}$ " | *Aspen available in light filtering only

OVATION	84"	96"	108"	120"
Linen Weave, Aspen*, Verona Textures & Boutique Light Filtering and Room Darkening Fabrics	6 $\frac{1}{2}$ "	7 $\frac{1}{4}$ "	8"	8 $\frac{3}{4}$ "

Ovations minimum fabric stack measures 6 $\frac{1}{2}$ " regardless of the ordered width. Fabric stacking dimensions are determined by the slider's hardware, not ordered width.

*Aspen available in light filtering only

Color Lux Cellular Shade Pricing Examples

Rechargeable Simplicity Pricing Example:

Linen Weave	
Light Filtering 42" x 60" Shade:	\$611.00
Simplicity Rechargeable Motor Surcharge:	\$300.00
Charger for Rechargeable:	\$30.00
Simplicity 14 Channel Remote Control:	\$50.00
Total List Price:	\$991.00

Motorized Top Down-Bottom Up Pricing Example:

Linen Weave	
Light Filtering 42" x 60" Shade:	\$611.00
Simplicity Rechargeable TDBU Surcharge*:	\$515.00
Charger for Rechargeable:	\$30.00
TDBU Remote Control**:	\$50.00
Total List Price:	\$1206.00

PowerTouch Rechargeable Pricing Example:

Linen Weave	
Light Filtering 42" x 60" Shade:	\$611.00
PowerTouch Rechargeable Surcharge:	\$100.00
Charger for Rechargeable:	\$30.00
Total List Price:	\$741.00

Cordless Ultra Two-On-One Pricing Example:

Linen Weave		
Light Filtering 42" x 60" Shade:	\$611.00	
	x2:	\$1222.00
Cordless Ultra Surcharge:	\$108.00	
	x2:	\$216.00
2-On-1 Surcharge:	\$66.00	
3 Foot Expandable Pole:	\$30.00	
Total List Price:	\$1534.00	

Rechargeable Simplicity with Solar Panel Pricing Example:

Linen Weave	
Light Filtering 42" x 60" Shade:	\$611.00
Simplicity Rechargeable Motor Surcharge:	\$300.00
Charger for Rechargeable:	\$30.00
Simplicity 14 Channel Remote Control:	\$50.00
Solar Panel & Mounting Brackets:	\$120.00
Total List Price:	\$1111.00

+Upcharge includes motorization plus second motor and Top Down-Bottom Up components

** TDBU Remote required for Motorized Top Down-Bottom Up shades

Color Lux® Cellular Shades

HARDWARE UPGRADE OPTIONS

LIFT SYSTEM	UPGRADES	ADD	DESIGNER UPGRADE OPTIONS	UPGRADES	ADD
Cord Lock	Top Down-Bottom Up	\$85	Add to Any Lift System Upgrade (Chart to the left)	Metallic Hardware	Included
	Bottom Up	No Extra Charge		Fabric Wrapped Hardware	Included
Cordless Lift & Lock Surcharge	Top Down-Bottom Up	\$108		Scotchgard Stain Protection	\$48
	Bottom Up	\$108	SlumberShades Light Blocking Sidetrack System	Insulating SlumberShades See Page 49 For More Information	\$174
Cordless Ultra	Top Down-Bottom Up	\$215			
	Color Lux StrataView	\$444			
	Bottom Up	\$108			
Cord Loop	Top Down-Bottom Up	\$215			
	Color Lux StrataView	\$444			
	Bottom Up	\$108			
ADDITIONAL OPTIONS	UPGRADES	ADD			
Add to Any Upgrade Above	Friction Fit Mounting System	\$93 per shade: Available with Cordless Ultra, Lift & Lock and Simplicity and PowerTouch motors (More information on page 46)			
	Two-On-One Head Rail	Price each panel as a separate shade, including lift system upgrades, add together, then add \$66			
	Cut Outs	\$69 Per side			
	StrataView™	\$444 (includes Top Down-Bottom Up & top sheer fabric additions) Available on Cordless Ultra, Cord Loop and motorized. (Not available with Aspen)			
	Ovation Center Stack	\$108			
	Soprano - Two Moving Rails	\$169			
Accessories	3 Foot Expandable Pole - Silver	\$30			
	5-10 Foot Expandable Pole - Black	\$54			

Cellular Shade **Motorized** Hardware Upgrade Options

MOTORIZED	UPGRADES	ADD	
7.4 V PowerTouch Rechargeable Motorization System	Rechargeable Integrated Battery Pack	\$100	For More Information Page 36
	Plug-In Charger for Rechargeable Li-Ion	\$30	
12V Simplicity Motorization System (non-rechargeable)	Motor and Battery Wand	\$300	For More Information Page 34
	48" Extension Wire	\$10	
	Single Unit DC Power Supply/Transformer	\$30	
7.4V Simplicity Rechargeable Motorization System with Quietude™ Technology	Motor and Integrated Battery Pack	\$300	For More Information Page 36
	Plug-In Charger for Rechargeable Li-Ion	\$30	
	7.4v Solar Panel & Mounting Brackets	\$120	
Simplicity Systems & Controllers	NEO Controller	\$280	For More Information Pages 34-46
	NEO App for Mobile Devices	FREE on App Store	
	Color Lux Mobile Bluetooth App	FREE on App Store	
	Top Down-Bottom Up/StrataView 14 Channel Remote***	\$50	
	StrataView™ Motorized	\$675	
	Top Down-Bottom Up Motorized	\$515	
7.4V EZ Charge Extension Wand	Wall Mount Receiver Kit	\$18	For More Information Page 41
	Extendable Wand	\$32	
12V Low Voltage Hardwiring	9 Channel Wall Mount Transformer	\$232	For More Information Page 42

Color Lux® Cellular Shades

PRICING GRIDS



1 Cord Lock | Cordless Lift & Lock
Color Lux Linen Weave, Aspen
& Verona Textures Light Filtering



2 Cord Lock | Cordless Lift & Lock
Color Lux Linen Weave
& Verona Textures Room Darkening



3 Cord Lock | Cordless Lift & Lock
Boutique Light Filtering



4 Cord Lock | Cordless Lift & Lock
Boutique Room Darkening



5 Ovation Cellular Slider
Color Lux Linen Weave, Aspen
& Verona Textures Light Filtering



6 Ovation Cellular Slider
Color Lux Linen Weave, Aspen
& Verona Textures Room Darkening



7 Ovation Cellular Slider
Boutique Light Filtering



8 Ovation Cellular Slider
Boutique Room Darkening



9 Starburst Arches | Quarter Rounds
Color Lux Linen Weave, Aspen, Verona
Textures & Boutique Light Filtering



10 Starburst Arches | Quarter Rounds
Color Lux Linen Weave, Verona Textures
& Boutique Room Darkening



11 Sunset Movable Arches
Color Lux Linen Weave, Aspen,
Verona Textures & Boutique Light Filtering



12 Sunset Movable Arches
Color Lux Linen Weave, Verona
Textures & Boutique Room Darkening



13 Trapezoids | Octagons
Color Lux Linen Weave, Aspen, Verona
Textures & Boutique Light Filtering



14 Trapezoids | Octagons
Color Lux Linen Weave, Verona
Textures & Boutique Room Darkening



15 Mezzo Motorized Skylights |
White Rail & Track
Color Lux Linen Weave, Aspen, Verona
Textures & Boutique Light Filtering



16 Mezzo Motorized Skylights |
White Rail & Track
Color Lux Linen Weave, Verona
Textures & Boutique Room Darkening



17 Soprano Skylights
Color Lux Linen Weave, Aspen, Verona
Textures & Boutique Light Filtering



18 Soprano Skylights
Color Lux Linen Weave, Verona
Textures & Boutique Room Darkening



19 Balcony Skylight Shading System
Color Lux Linen Weave, Aspen, Verona
Textures & Boutique Light Filtering



20 Balcony Skylight Shading System
Color Lux Linen Weave, Verona
Textures & Boutique Room Darkening



21 Non-Movable French Door Decors
Color Lux Linen Weave, Aspen, Verona
Textures & Boutique Light Filtering



22 Non-Movable French Door Decors
Color Lux Linen Weave, Verona
Textures & Boutique Room Darkening



23 Movable French Door Decors
Color Lux Linen Weave, Aspen, Verona
Textures & Boutique Light Filtering



24 Movable French Door Decors
Color Lux Linen Weave, Verona
Textures & Boutique Room Darkening

Color Lux® Cellular Shades

PRICING

Color Lux® Linen Weave, Aspen, Verona Textures Light Filtering & StrataView Sheer Fabric

Price Group 1

Cord Lock - Fabric Wrapped or Designer Metallic Rails Cordless Lift & Lock - Fabric Wrapped or Designer Metallic Rail

		Width In Inches											
		24	30	36	42	48	54	60	66	72	84	96	108
Length In Inches	36	317	348	396	437	477	518	559	595	637	726	812	898
	42	336	381	423	473	518	564	611	654	699	798	894	992
	48	352	405	457	506	559	610	658	713	761	886	1006	1129
	54	376	428	484	539	597	653	720	786	856	992	1129	1266
	60	399	456	518	578	636	720	795	869	946	1099	1249	1400
	66	415	477	549	622	703	786	869	952	1036	1205	1371	1538
	72	437	502	578	673	765	856	946	1036	1129	1312	1493	1675
	78	457	531	627	726	825	924	1023	1122	1218	1416	1614	1809
	84	471	567	673	781	886	992	1099	1205	1312	1521	1734	1948
	90	489	607	720	833	946	1061	1175	1288	1400	1628	1856	2082
	96	524	643	765	886	1006	1129	1249	1371	1493	1734	1977	2219
	108	583	720	856	992	1129	1266	1400	1538	1675	1948	2219	2491
120	643	795	946	1099	1249	1400	1552	1702	1856	2159	2459	2764	

Motorized Lift Systems are not offered within the shaded area. Selected Linen Weave light filtering fabrics are available up to 120" widths. Colors 001, 002, 005 & 006

LIFT SYSTEM	UPGRADES	ADD
Cord Lock	Top Down-Bottom Up	\$85
	Cordless Lift & Lock Surcharge	No Extra Charge
Cordless Ultra	Bottom Up	\$108
	Top Down-Bottom Up	\$215
	Color Lux StrataView	\$444
Cord Loop	Bottom Up	\$108
	Top Down-Bottom Up	\$215
	Color Lux StrataView	\$444

DESIGNER UPGRADE OPTIONS	UPGRADES	ADD
Add to Any Lift System Upgrade (Chart to the left)	Metallic Hardware	Included
	Fabric Wrapped Hardware	Included
	Scotchgard Stain Protection See Page 73 for more information.	\$48

ADDITIONAL OPTIONS	UPGRADES	ADD
Add to Any Upgrade Above	Friction Fit Mounting System	\$93 per shade: Available with Cordless Ultra, Lift & Lock and Simplicity and PowerTouch motors (More information on page 46)
	Two-On-One Head Rail	Price each panel as a separate shade, including lift system upgrades, add together, then add \$66
	Cut Outs	\$69 Per side. See page 75 for more information.
	Day-Night	Price each panel as separate shade and add together
	StrataView™	\$444 (includes Top Down-Bottom Up & top sheer fabric additions)
Accessories	3 Foot Expandable Pole - Silver	\$30
	5-10 Foot Expandable Pole - Black	\$54
MOTORIZATION	MORE INFO	
Motorized Pricing Examples - Surcharges - Options	Pg 8-9	
Insulating SlumberShades	\$174 See Page 49 For More Information. Not available with StrataView.	

Color Lux® Cellular Shades

PRICING

Color Lux® Linen Weave & Verona Textures Room Darkening

Price Group 2

Cord Lock - Fabric Wrapped or Designer Metallic Rails Cordless Lift & Lock - Fabric Wrapped or Designer Metallic Rail

		Width In Inches											
		24	30	36	42	48	54	60	66	72	84	96	108
Length In Inches	36	411	452	512	568	622	673	726	773	827	945	1055	1167
	42	437	494	549	614	673	732	794	849	908	1038	1161	1290
	48	457	527	595	658	726	793	854	926	990	1152	1308	1466
	54	489	556	630	700	775	847	937	1022	1112	1290	1466	1645
	60	518	592	673	751	827	937	1034	1130	1230	1427	1623	1820
	66	540	622	714	809	915	1022	1130	1238	1346	1567	1783	1999
	72	568	653	751	874	994	1112	1230	1346	1466	1706	1939	2177
	78	595	690	815	945	1073	1201	1330	1459	1585	1840	2099	2352
	84	611	737	874	1017	1152	1290	1427	1567	1706	1977	2255	2531
	90	636	788	937	1082	1230	1380	1527	1673	1820	2116	2414	2705
	96	680	837	994	1152	1308	1466	1623	1783	1939	2255	2570	2885
	108	758	937	1112	1290	1466	1645	1820	1999	2177	2531	2885	3238
120	837	1034	1230	1427	1623	1820	2019	2213	2414	2807	3199	3593	

Motorized Lift Systems are not offered within the shaded area.

LIFT SYSTEM	UPGRADES	ADD
Cord Lock	Top Down-Bottom Up	\$85
	Cordless Lift & Lock Surcharge	No Extra Charge
Cordless Ultra	Bottom Up	\$108
	Top Down-Bottom Up	\$215
	Color Lux StrataView	\$444
Cord Loop	Bottom Up	\$108
	Top Down-Bottom Up	\$215
	Color Lux StrataView	\$444

DESIGNER UPGRADE OPTIONS	UPGRADES	ADD
Add to Any Lift System Upgrade (Chart to the left)	Metallic Hardware	Included
	Fabric Wrapped Hardware	Included
	Scotchgard Stain Protection	\$48

ADDITIONAL OPTIONS	UPGRADES	ADD
Add to Any Upgrade Above	Friction Fit Mounting System	\$93 per shade: Available with Cordless Ultra, Lift & Lock and Simplicity and PowerTouch motors (More informaton on page 46)
	Two-On-One Head Rail	Price each panel as a separate shade, including lift system upgrades, add together, then add \$66
	Cut Outs	\$69 Per side
	Day-Night	Price each panel as separate shade and add together
	StrataView™	\$444 (includes Top Down-Bottom Up & top sheer fabric additions)
Accessories	3 Foot Expandable Pole - Silver	\$30
	5-10 Foot Expandable Pole - Black	\$54
MOTORIZATION	MORE INFO	
Motorized Pricing Examples - Surcharges - Options	Pg 8-9	
Insulating SlumberShades	\$174 See Page 49 For More Information. Not available with StrataView.	

Color Lux® Cellular Shades

PRICING

Boutique Light Filtering

Price Group 3

Cord Lock - Fabric Wrapped or Designer Metallic Rails
Cordless Lift & Lock - Fabric Wrapped or Designer Metallic Rail

		Width In Inches											
		24	30	36	42	48	54	60	66	72	84	96	108
Length In Inches	36	367	401	454	503	549	595	643	683	733	836	934	1033
	42	387	438	487	544	595	648	703	752	804	919	1028	1142
	48	405	467	526	583	643	702	756	820	876	1020	1158	1296
	54	434	492	557	619	686	751	828	904	983	1142	1296	1456
	60	460	525	595	665	732	828	915	1000	1087	1264	1437	1610
	66	477	549	632	715	810	904	1000	1096	1191	1386	1577	1768
	72	503	577	665	774	880	983	1087	1191	1296	1510	1718	1927
	78	526	611	722	836	949	1063	1177	1291	1401	1628	1857	2081
	84	541	653	774	899	1020	1142	1264	1386	1510	1748	1994	2241
	90	564	698	828	959	1087	1219	1351	1481	1610	1873	2135	2395
	96	602	739	880	1020	1158	1296	1437	1577	1718	1994	2275	2551
	108	671	828	983	1142	1296	1456	1610	1768	1927	2241	2551	2866
120	739	915	1087	1264	1437	1610	1786	1957	2135	2485	2828	3179	

Motorized Lift Systems are not offered within the shaded area. Selected Linen Weave light filtering fabrics are available up to 120" widths. Colors 001, 002, 005 & 006

Boutique Room Darkening

Price Group 4

Cord Lock - Fabric Wrapped or Designer Metallic Rails
Cordless Lift & Lock - Fabric Wrapped or Designer Metallic Rail

		Width In Inches											
		24	30	36	42	48	54	60	66	72	84	96	108
Length In Inches	36	473	522	589	654	715	774	836	889	952	1086	1214	1342
	42	503	568	632	706	774	842	914	975	1046	1193	1335	1484
	48	526	607	683	756	836	912	982	1065	1139	1325	1504	1687
	54	564	640	724	806	892	975	1078	1176	1279	1484	1687	1892
	60	595	680	774	865	950	1078	1189	1300	1415	1642	1867	2094
	66	622	715	821	931	1053	1176	1300	1426	1549	1802	2051	2299
	72	654	751	865	1007	1142	1279	1415	1549	1687	1962	2230	2504
	78	683	794	937	1086	1234	1381	1531	1677	1823	2116	2413	2705
	84	703	849	1007	1170	1325	1484	1642	1802	1962	2275	2592	2911
	90	732	906	1078	1246	1415	1588	1757	1925	2094	2434	2777	3112
	96	782	963	1142	1325	1504	1687	1867	2051	2230	2592	2957	3318
	108	871	1078	1279	1484	1687	1892	2094	2299	2504	2911	3318	3725
120	963	1189	1415	1642	1867	2094	2322	2545	2777	3229	3679	4132	

Motorized Lift Systems are not offered within the shaded area. Selected Linen Weave light filtering fabrics are available up to 120" widths. Colors 001, 002, 005 & 006

MOTORIZATION	MORE INFO
Motorized Pricing Examples - Surcharges - Options	Pg 8-9
Insulating SlumberShades	\$174 See Page 49 For More Information. Not available with StrataView.

Color Lux® Cellular Shades

PRICING

Color Lux® Linen Weave, Aspen & Verona Textures Light Filtering

Price Group 5 Ovation Cellular Slider

		Width In Inches																	
		24	30	36	42	48	54	60	66	72	78	84	96	108	120	132	144	156	168
Length In Inches	36	690	748	814	873	924	987	1049	1103	1163	1231	1284	1388	1493	1606	1715	1827	1941	2053
	42	733	804	874	946	1003	1071	1144	1206	1279	1344	1403	1525	1643	1778	1906	2036	2167	2299
	48	781	852	941	1016	1082	1154	1234	1312	1386	1451	1528	1672	1797	1943	2087	2230	2372	2518
	54	824	912	999	1083	1155	1237	1318	1409	1493	1571	1654	1808	1954	2111	2271	2427	2590	2747
	60	870	964	1057	1151	1234	1323	1415	1510	1598	1686	1775	1944	2107	2277	2455	2627	2800	2979
	66	920	1020	1122	1219	1312	1409	1502	1615	1706	1808	1889	2087	2259	2447	2628	2815	3000	3186
	72	970	1074	1183	1293	1397	1494	1597	1714	1819	1924	2016	2233	2410	2619	2826	3038	3246	3454
	78	1020	1133	1249	1368	1476	1585	1692	1820	1927	2037	2138	2364	2563	2785	3003	3225	3447	3668
	84	1071	1189	1310	1443	1559	1672	1787	1922	2037	2158	2263	2505	2716	2948	3186	3420	3651	3884
	90	1116	1243	1380	1517	1631	1760	1885	2028	2150	2274	2393	2648	2866	3124	3383	3642	3901	4161
96	1162	1300	1444	1588	1712	1840	1986	2131	2263	2396	2515	2790	3024	3288	3555	3822	4090	4353	
108	1208	1350	1506	1660	1789	1927	2081	2228	2372	2515	2640	2932	3179	3454	3726	4001	4272	4545	

Color Lux® Linen Weave & Verona Textures Room Darkening

Price Group 6 Ovation Cellular Slider

		Width In Inches																	
		24	30	36	42	48	54	60	66	72	78	84	96	108	120	132	144	156	168
Length In Inches	36	896	971	1057	1134	1203	1281	1363	1434	1515	1598	1669	1806	1941	2087	2229	2376	2523	2668
	42	952	1046	1137	1230	1304	1391	1487	1568	1663	1748	1823	1983	2135	2310	2478	2648	2818	2989
	48	1017	1108	1222	1318	1409	1498	1603	1705	1803	1886	1986	2173	2337	2525	2713	2900	3083	3273
	54	1070	1185	1296	1409	1502	1611	1711	1833	1941	2041	2150	2351	2539	2742	2952	3154	3366	3572
	60	1132	1251	1374	1493	1603	1722	1839	1963	2078	2192	2305	2527	2737	2961	3191	3414	3642	3874
	66	1196	1326	1458	1588	1705	1830	1953	2099	2218	2351	2455	2713	2936	3181	3416	3659	3899	4141
	72	1262	1397	1538	1682	1815	1944	2077	2228	2363	2501	2622	2901	3133	3403	3673	3950	4219	4488
	78	1326	1474	1623	1778	1918	2058	2199	2366	2504	2650	2777	3074	3330	3618	3905	4191	4483	4768
	84	1391	1546	1703	1877	2025	2173	2324	2496	2650	2802	2941	3257	3531	3831	4141	4446	4747	5050
	90	1451	1617	1794	1971	2122	2287	2450	2635	2794	2954	3111	3442	3726	4062	4398	4733	5072	5407
96	1512	1689	1878	2063	2226	2393	2581	2770	2941	3115	3271	3627	3931	4275	4621	4968	5319	5660	
108	1570	1753	1957	2159	2325	2504	2705	2896	3082	3271	3433	3815	4132	4490	4844	5201	5555	5908	

PRODUCT INFORMATION

See Page 47 for detailed information.

DESIGN UPGRADES

Scotchgard Stain Protector	Add \$48 per shade
Center Stack	Add \$108 Left or Right Stack Standard
Split Stack*	Price by dividing the full width measurement in half. Price as two separate units and add together.
Dual Panel**	Price as two separate units and add together.

* Split stack sliders are available in widths up to 240". If the width exceeds 120", it will be fabricated as two separate sliders. The supplied valance will create the appearance of a single slider.

** A Dual Panel Stack Slider has a center opening design with a different fabric on each side, each of which can span the full width of the window. Both panels will be of equal width unless otherwise specified.

Color Lux® Cellular Shades

PRICING

Boutique Light Filtering

Price Group 7 Ovation Cellular Slider

		Width In Inches																	
		24	30	36	42	48	54	60	66	72	78	84	96	108	120	132	144	156	168
Length In Inches	36	794	860	936	1004	1063	1134	1207	1268	1339	1416	1476	1597	1718	1847	1974	2102	2233	2362
	42	844	925	1007	1087	1154	1233	1315	1387	1472	1547	1614	1756	1890	2045	2192	2342	2492	2644
	48	899	980	1082	1168	1246	1328	1419	1510	1594	1670	1758	1924	2067	2234	2400	2564	2730	2895
	54	946	1049	1149	1247	1329	1425	1515	1623	1718	1807	1902	2080	2247	2427	2610	2791	2979	3157
	60	1001	1109	1216	1323	1419	1522	1627	1738	1839	1939	2041	2236	2423	2619	2824	3022	3220	3425
	66	1058	1172	1291	1403	1510	1618	1728	1858	1962	2080	2171	2400	2598	2815	3023	3236	3450	3663
	72	1116	1235	1360	1489	1607	1719	1837	1973	2091	2213	2318	2568	2772	3012	3250	3496	3734	3971
	78	1172	1304	1437	1573	1699	1823	1946	2094	2216	2343	2458	2719	2947	3202	3454	3709	3965	4218
	84	1233	1368	1509	1660	1794	1924	2056	2211	2343	2482	2603	2882	3123	3391	3663	3932	4199	4468
	90	1284	1429	1588	1745	1878	2023	2170	2333	2473	2615	2752	3045	3296	3593	3893	4187	4488	4784
96	1338	1494	1661	1825	1969	2116	2283	2450	2603	2755	2893	3209	3478	3782	4089	4395	4705	5007	
108	1389	1552	1732	1910	2057	2216	2393	2563	2729	2893	3036	3374	3656	3972	4284	4601	4913	5227	

Boutique Room Darkening

Price Group 8 Ovation Cellular Slider

		Width In Inches																	
		24	30	36	42	48	54	60	66	72	78	84	96	108	120	132	144	156	168
Length In Inches	36	1032	1117	1216	1305	1383	1474	1568	1651	1742	1839	1919	2077	2233	2401	2563	2732	2902	3068
	42	1096	1203	1308	1415	1500	1601	1711	1803	1912	2010	2096	2280	2456	2657	2851	3045	3240	3438
	48	1170	1274	1405	1515	1618	1723	1843	1960	2074	2170	2283	2500	2686	2903	3120	3335	3547	3763
	54	1231	1363	1493	1623	1728	1853	1968	2108	2233	2348	2473	2704	2921	3154	3395	3628	3873	4107
	60	1302	1439	1580	1718	1843	1980	2115	2259	2391	2522	2652	2907	3149	3405	3670	3926	4187	4454
	66	1376	1524	1676	1825	1960	2105	2246	2414	2551	2704	2824	3120	3377	3658	3929	4209	4484	4762
	72	1451	1606	1768	1933	2087	2236	2389	2563	2718	2876	3015	3337	3604	3914	4225	4542	4851	5161
	78	1524	1694	1867	2045	2205	2368	2527	2721	2881	3047	3195	3534	3830	4162	4490	4819	5154	5483
	84	1601	1778	1958	2158	2329	2500	2673	2872	3047	3224	3383	3745	4062	4407	4762	5114	5458	5808
	90	1670	1860	2063	2266	2439	2629	2818	3031	3215	3397	3577	3959	4284	4672	5058	5444	5833	6219
96	1739	1943	2158	2372	2561	2752	2969	3186	3383	3582	3763	4170	4521	4917	5315	5713	6117	6509	
108	1806	2016	2251	2485	2674	2881	3111	3330	3545	3763	3949	4387	4754	5164	5570	5981	6390	6795	

PRODUCT INFORMATION

See Page 47 for detailed information.

DESIGN UPGRADES

Scotchgard Stain Protector	Add \$48 per shade
Center Stack	Add \$108 Left or Right Stack Standard
Split Stack*	Price by dividing the full width measurement in half. Price as two separate units and add together.
Dual Panel**	Price as two separate units and add together.

* Split stack sliders are available in widths up to 240". If the width exceeds 120", it will be fabricated as two separate sliders. The supplied valance will create the appearance of a single slider.

** A Dual Panel Stack Slider has a center opening design with a different fabric on each side, each of which can span the full width of the window. Both panels will be of equal width unless otherwise specified.

Color Lux® Cellular Shades

PRICING

Color Lux® Linen Weave, Aspen, Verona Textures & Boutique Light Filtering

Price Group 9
Starburst Arches
Quarter Rounds

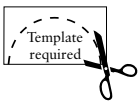

For widths wider than 58"

Fabric Wrapped or Designer Metallic Hardware Included

		Width In Inches								
		24	30	36	42	48	54	60	66	72
Length In Inches	Non-Movable Starburst	405	456	512	581	689	782	877	987	1106
	Movable Starburst	559	627	710	797	946	1057	1185	1321	1471
	Non-Movable Quarter Rounds	512	581	656	744	839	949			
	Movable Quarter Rounds	689	774	874	981	1106				

Color Lux® Linen Weave, Verona Textures & Boutique Room Darkening

Price Group 10
Starburst Arches
Quarter Rounds

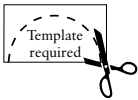

For widths wider than 58"

Fabric Wrapped or Designer Metallic Hardware Included

		Width In Inches								
		24	30	36	42	48	54	60	66	72
Length In Inches	Non-Movable Starburst	559	624	699	786	925	1049	1172	1314	1471
	Movable Starburst	758	849	953	1070	1264	1407	1572	1750	1944
	Non-Movable Quarter Rounds	699	786	886	999	1124	1267			
	Movable Quarter Rounds	925	1041	1171	1308	1471				

Non-Movable Starburst Product Information:

Templates required on non-perfect non-movable Starburst Arches. See page 75 for more information.

Fabric wrapped rail is standard. There will be a splice in the center. A decorative rosette is supplied to cover the splice.

Pricing Information:

Price according to the largest radius measurement. If the height is greater than the width, take height multiplied by 2 and use that number to determine pricing.

FABRIC SURCHARGES		ADD
Scotchgard Stain Protector		\$48
PRICING INFORMATION		
Starburst Arches	Price according to the largest radius measurement. If the height is greater than the width, take height X 2 and use that number to determine pricing. Metallic rails available.	
Quarter Rounds	Price according to the largest radius measurement.	
HARDWARE UPGRADE SURCHARGES* AND ACCESSORIES		ADD
Metallic Hardware or Fabric Wrapped Rails		Included
5-10 Foot Expandable Pole - Black		\$54

Color Lux® Cellular Shades
PRICING

**Color Lux® Linen Weave, Aspen,
 Verona Textures & Boutique Light Filtering
 Fabric Wrapped or Designer Metallic Hardware Included**

**Price Group 11
 Sunset Movable Arches**

		Width In Inches								
		24	30	36	42	48	54	60	66	72
Length In Inches	Half Round	513	568	601	671	714	796	844	924	1006
	36	656	715	749	797	831	890	916	964	1006
	42	690	758	788	862	891	958	988	1041	1087
	48	731	797	839	914	946	1000	1059	1113	1172
	60	795	890	932	1025	1070	1158	1206	1274	1342

Sunset Product Information:
 Templates required on non-perfect Sunset Arches. See page 75.

**Color Lux® Linen Weave, Verona Textures
 & Boutique Room Darkening**

**Price Group 12
 Sunset Movable Arches**
Fabric Wrapped or Designer Metallic Hardware Included

		Width In Inches						
		24	30	36	42	48	54	60
Length In Inches	Half Round	660	731	772	862	917	1024	1086
	36	842	919	964	1025	1071	1148	1182
	42	887	975	1016	1112	1149	1235	1274
	48	938	1025	1082	1177	1218	1290	1368
	60	1023	1148	1203	1323	1380	1494	1556

Sunset Product Information:
 Templates required on non-perfect Sunset Arches. See page 75.

PRODUCT INFORMATION		
	See Page 56 for detailed information.	
DESIGN UPGRADES		
	Scotchgard Stain Protector	Add \$48 per shade
	3 Foot Expandable Pole - Silver	Add \$30
	5-10 Foot Expandable Pole - Black	Add \$54

Color Lux® Cellular Shades
PRICING

**Color Lux® Linen Weave, Aspen,
 Verona Textures & Boutique Light Filtering
 Fabric Wrapped or Designer Metallic Hardware Included**

Price Group 13
Trapezoids and Octagons

		Width In Inches				
		24	30	36	42	48
Length In Inches	36	697	736	785	839	886
	42	720	768	821	877	929
	48	741	796	860	919	973
	54	767	824	891	953	1019
	60	791	854	928	995	1061
	66	815	886	964	1035	1112
	72	839	911	995	1078	1158

**Color Lux® Linen Weave, Verona Textures
 & Boutique Room Darkening
 Fabric Wrapped or Designer Metallic Hardware Included**

Price Group 14
Trapezoids and Octagons

		Width In Inches				
		24	30	36	42	48
Length In Inches	36	895	946	1011	1079	1139
	42	928	988	1057	1130	1199
	48	952	1024	1106	1184	1254
	54	987	1059	1149	1232	1313
	60	1019	1100	1196	1284	1370
	66	1049	1139	1243	1335	1435
	72	1079	1172	1284	1389	1494

PRODUCT INFORMATION	
	See page 58 for detailed information. Width, length and one side are required measurements for Octagon Shades. Trapezoid orders must be faxed in with a diagram that includes the measurements for 4 sides. Max width of trapezoid is 48", this refers to full width of top rail.
DESIGN UPGRADES	
	Scotchgard Stain Protector Add \$48 per shade

Color Lux® Cellular Shades
PRICING

**Color Lux® Linen Weave, Aspen,
 Verona Textures & Boutique Light Filtering**

Price Group 15
Mezzo Motorized Skylights
White Rail and White Track

		Width In Inches				
		24	30	36	42	48
Length In Inches	36	624	706	785	876	948
	42	661	749	850	938	1038
	48	695	803	899	1003	1112
	54	735	849	958	1063	1200
	60	761	892	1008	1130	1288
	66	803	933	1059	1187	1370
	72	849	987	1106	1233	1443

Be sure to add the Simplicity motor surcharges and upgrades to the grid above.

**Color Lux® Linen Weave, Verona Textures
 & Boutique Room Darkening**

Price Group 16
Mezzo Motorized Skylights
White Rail and White Track

		Width In Inches				
		24	30	36	42	48
Length In Inches	36	801	907	1011	1130	1224
	42	850	965	1095	1208	1341
	48	894	1034	1159	1293	1435
	54	946	1094	1235	1372	1549
	60	980	1151	1302	1459	1663
	66	1034	1204	1368	1534	1772
	72	1094	1271	1429	1593	1866

Be sure to add the Simplicity motor surcharges and upgrades to the grid above.

MOTORIZED	UPGRADES	ADD	
Simplicity Rechargeable Motorization System	Motor and Battery Wand	\$300	For More Information Page 34-41
	Simplicity 14 Channel White Remote	\$50	
	Plug-In Charger for Rechargeable Li-Ion	\$30	
Simplicity Smart Controller System	NEO Controller	\$280	For More Information Page 43
	NEO App for Mobile Devices	FREE on App Store	
	Color Lux Mobile BlueTooth App	FREE on App Store	

Color Lux® Cellular Shades PRICING

Color Lux® Linen Weave, Aspen, Verona Textures & Boutique Light Filtering

Price Group 17 Soprano Skylights

		Width In Inches					
		26	30	34	38	42	48
Length In Inches	30	774	824	874	922	971	1027
	36	835	891	946	1000	1055	1112
	42	894	959	1019	1078	1141	1205
	48	959	1027	1095	1154	1222	1295
	54	1019	1099	1166	1233	1302	1381
	60	1082	1166	1237	1313	1384	1469
	72	1208	1293	1381	1467	1552	1653

Color Lux® Linen Weave, Verona Textures & Boutique Room Darkening

Price Group 18 Soprano Skylights

		Width In Inches					
		26	30	34	38	42	48
Length In Inches	30	1006	1070	1137	1199	1263	1334
	36	1083	1158	1230	1300	1372	1446
	42	1161	1246	1322	1400	1485	1565
	48	1246	1334	1421	1498	1588	1683
	54	1322	1427	1516	1601	1693	1795
	60	1409	1516	1607	1706	1798	1911
	72	1570	1682	1795	1910	2019	2147

PRODUCT INFORMATION

See Page 63 for detailed information.

DESIGN UPGRADES

Scotchgard Stain Protector	Add \$48 per shade
5-10 Foot Expandable Pole - Black	Add \$54

Color Lux® Cellular Shades
PRICING

**Color Lux® Linen Weave, Aspen,
 Verona Textures & Boutique Light Filtering**

PRICE GROUP 19
Balcony Skylight Shading System

		Width In Inches				
		24	30	36	42	48
Length In Inches	36	547	623	694	775	845
	42	578	663	752	835	926
	48	607	710	798	895	994
	54	647	751	852	950	1079
	60	672	795	902	1010	1154
	66	710	831	949	1061	1232
	72	751	874	990	1108	1300
	78	795	908	1035	1154	
	84	839	952	1080	1203	
	90	894	990	1124		
	96	934	1032	1172		

**Color Lux® Linen Weave, Verona Textures
 & Boutique Room Darkening**

PRICE GROUP 20
Balcony Skylight Shading System

		Width In Inches				
		24	30	36	42	48
Length In Inches	36	710	810	903	1008	1097
	42	751	862	978	1083	1204
	48	791	922	1038	1162	1291
	54	842	977	1108	1235	1403
	60	874	1034	1172	1313	1500
	66	922	1080	1234	1380	1600
	72	977	1138	1287	1439	1689
	78	1034	1182	1345	1500	
	84	1091	1238	1404	1563	
	90	1161	1287	1461		
	96	1214	1341	1522		

All fabrics are not available in all widths, lengths and applications. Refer to Size Specifications on page 6 for availability.

Product Information: See page 65 for detailed information.

- Shades are built with color coordinating hardware and white track.
- Designer metallic and fabric wrapped rails are available.

FABRIC SURCHARGES	ADD
Scotchgard Stain Protector	\$48
HARDWARE UPGRADE SURCHARGES AND ACCESSORIES	ADD
Metallic Hardware or Fabric Wrapped Rails	Included
3 Foot Expandable Pole - Silver	Add \$30
5-10 Foot Expandable Pole - Black	Add \$54

Color Lux® Cellular Shades
PRICING

**Color Lux® Linen Weave, Aspen,
 Verona Textures & Boutique Light Filtering** **Price Group 21**
Non-Movable French Door Decors
Fabric Wrapped or Designer Metallic Hardware Included

		Width In Inches				
		12	18	24	30	36
Length In Inches	36	171	179	188	206	230
	42	179	189	200	222	244
	48	188	200	208	234	263
	54	200	209	219	246	280
	60	209	220	232	261	294
	66	219	232	242	277	313
	72	226	239	252	286	327
	78	238	251	263	300	342
	84	245	259	271	315	356
	90	256	270	283	327	373
96	261	277	292	338	388	

**Color Lux® Linen Weave, Verona Textures
 & Boutique Room Darkening** **Price Group 22**
Non-Movable French Door Decor
Fabric Wrapped or Designer Metallic Hardware Included

		Width In Inches				
		12	18	24	30	36
Length In Inches	36	212	224	234	259	290
	42	224	235	247	280	306
	48	235	250	261	294	333
	54	247	261	275	310	354
	60	263	279	292	329	372
	66	275	292	305	351	398
	72	285	301	317	363	417
	78	299	316	333	381	434
	84	310	325	342	399	452
	90	322	341	358	415	476
96	333	351	369	429	494	

PRODUCT INFORMATION	
	See Page 67 for detailed information.
DESIGN UPGRADES	
Scotchgard Stain Protector	Add \$48 per shade

Color Lux® Cellular Shades

PRICING

Color Lux® Linen Weave, Aspen,
Verona Textures & Boutique Light Filtering
Fabric Wrapped or Designer Metallic Hardware Included

Price Group 23
Movable French Door Decors

		Width In Inches				
		12	18	24	30	36
Length In Inches	36	305	321	336	371	413
	42	321	339	356	398	435
	48	336	356	373	420	472
	54	356	375	393	443	505
	60	375	396	415	468	528
	66	393	415	434	496	562
	72	406	430	452	514	589
	78	426	450	472	540	614
	84	439	464	486	565	640
	96	468	496	519	607	697

Color Lux® Linen Weave, Verona Textures
& Boutique Room Darkening

Price Group 24
Movable French Door Decor
Fabric Wrapped or Designer Metallic Hardware Included

		Width In Inches				
		12	18	24	30	36
Length In Inches	36	377	400	420	464	518
	42	400	423	445	502	551
	48	423	447	468	528	595
	54	445	468	492	557	636
	60	472	499	524	589	667
	66	492	519	547	627	714
	72	512	541	568	653	749
	78	538	565	595	685	779
	84	555	584	614	716	814
	96	595	627	660	770	887

PRODUCT INFORMATION		
	See Page 67 for detailed information.	
DESIGN UPGRADES		
	Top Down-Bottom Up	Add \$85
	Scotchgard Stain Protector	Add \$48 per shade
	5-10 Foot Expandable Pole - Black	Add \$54



 **Standard Hardware**

 **7.4V Rechargeable
Simplicity Motorization**

 **Cord Loop Hardware**

 **7.4V Rechargeable
Powertouch**

 **Cordless Ultra Hardware**

 **Ovation Hardware**

 **Cordless Lift & Lock
Hardware**

 **Insulating Slumbershades
Hardware**

 **Simplicity Bluetooth
Motorization *with Quietude™ Technology***

 **Strataview Hardware**

 **12V Non-Rechargeable
Simplicity Motorization**

 **Specialty Shape Hardware**

Color Lux® Cellular Shades
STANDARD CORD LOCK SHADES HARDWARE SYSTEM

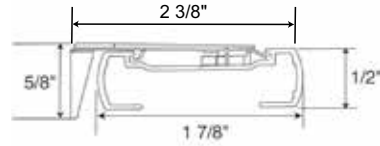

Cord Lock Rail

- Depth of rail: 1 7/8"
- Depth of rail and bracket: 2 3/8"
- Height: 1/2"
- Height of bracket: 5/8"

Hardware Features	
Fabric Wrapped	Fabric used is same fabric as the shade. Back of rail is white to outside. Color coordinated end caps with white cord and tassel
Designer Metallic	• Oil Rubbed Bronze head and bottom rails with bronze colored tassel, end caps and white cord.
Mounting Dimensions	
Mounting Dimensions	Cord Lock Rail
Minimum Shallow Mount	3/4"
Minimum Flush Inside Mount	2 3/8"
Minimum Outside Mount	3/4"
Minimum Side Mount	1 3/8"
Recommended Side Mounting Method	<ul style="list-style-type: none"> • See figure B (pg 26) for recommended mounting method for side mount shades • Width limit for side mount brackets is 48"
Finished Dimensions	
Inside and Side Mount	
	<ul style="list-style-type: none"> • Fabric will measure ordered width less: 3/8" • Head rail* will measure ordered width less: 3/16"
Outside Mount	
	<ul style="list-style-type: none"> • Fabric will measure ordered width • Head rail* will measure ordered width plus: 3/16"
Exact (End Cap to End Cap) Mount	
	<ul style="list-style-type: none"> • Fabric will measure ordered width less: 3/16" • Head rail* will measure ordered width
* Head rail measurements include endcaps. Width and length measurements may vary +/- 1/8"	

Color Lux® Cellular Shades

STANDARD CORD LOCK SHADES HARDWARE SYSTEM

Applications

- Standard Rectangular
- Day-Night
- Trapezoids and Octagons
- Top Down - Bottom Up
- Two-On-One Head Rail

Things to Consider

- If child safety is a concern, consider cordless options: Cordless Ultra, Cordless Lift & Lock or Motorization.
- Larger shades can be difficult to operate. Consider Cord Loop, Cordless Ultra or Motorization hardware.
- If privacy is an issue, consider Top Down-Bottom Up options.

Recommended Mounting Method for Side Mount Shades

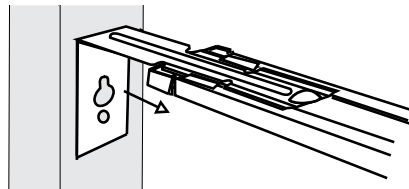

Figure B

EZ Level on Cellular Shades

EZ Level makes quick work of leveling without cords to cut or tuck into a rail. See page 72 for details.

Day-Night Shades

See pages 69-70 for more information.

Specialties (Trapezoids and Octagons)

See pages 58-59 for more information.



Color Lux® Cellular Shades
CORD LOOP HARDWARE SYSTEM

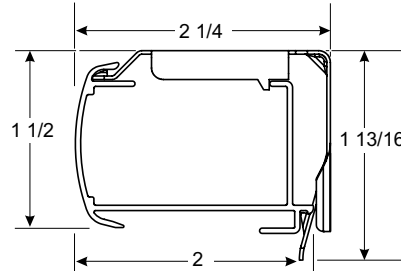

Cord Loop Rail Dimensions

- Depth of rail: 2"
- Depth of rail and bracket: 2 1/4"
- Height of rail: 1 1/2"
- Height of bracket: 1 13/16"

Hardware Features

Fabric Wrapped	Fabric used is same fabric as the shade. Back of rail is white to outside. Clutch cover will be white. Frosted clear with fabric insert end caps with white cord.
Designer Metallic	• Oil Rubbed Bronze head and bottom rails with bronze colored end caps and cord.

Mounting Dimensions

Cord Loop Hardware System

Minimum Shallow Mount	1/2"
Minimum Flush Inside Mount	2 1/4"
Minimum Outside Mount	7/8"
Minimum Side Mount	1 1/4"
Recommended Side Mounting Method	<ul style="list-style-type: none"> • See figure A (pg 26) for recommended mounting method for side mount shades • Width limit for side mount brackets is 48"

Finished Dimensions

Inside Mount

- Fabric will measure ordered width less: 3/8"
- Head rail* will measure ordered width less: 3/16"

Outside Mount

- Fabric will measure ordered width
- Head rail* will measure ordered width plus: 3/16"

Side Mount

- Fabric will measure ordered width less: 7/8"
- Head rail* will measure ordered width less: 1 1/16"

Exact (End Cap to End Cap) Mount

- Fabric will measure ordered width less: 3/16"
- Head rail* will measure ordered width

* Head rail measurements include endcaps. Width and length measurements may vary +/- 1/8"

Color Lux® Cellular Shades

CORD LOOP HARDWARE SYSTEM

Applications

- Standard Rectangular
- Two-On-One Head Rail
- Top Down - Bottom Up

Cord Loop Hardware System Features

Cord loops are available 2' to 15' lengths in 1' intervals. Please specify length when ordering. Standard loop sizes are as follows:

Shade Length	Standard Loop
Up to and including 26 ⁷ / ₈ "	1' (12")
27" to 39 ⁷ / ₈ "	2' (24")
40" to 59 ⁷ / ₈ "	3' (36")
60" to 83 ⁷ / ₈ "	4' (48")
84" to 107 ⁷ / ₈ "	5' (60")
108" and greater	6' (72")

Cord loops over 6' in length will be white.

Recommended Mounting Method for Side Mounting Shades

Width limit for side mount brackets is 48".

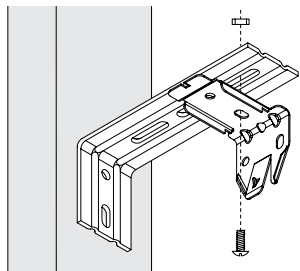

Cord Loop Hardware
 Cordless Ultra Hardware
 Cordless Ultra Top Down -
 Bottom Up Hardware

Figure A

Refer to the installation instructions on Comfortex.com/comfortex-dealers or the OnDemand Mobile Library for further details on side mounting shades.

Ordering Information for Cord Loop Hardware Shades

Standard Rectangular

- Specify IB or OB mount, rail color and left or right lift cord.
- Specify cord loop length when ordering.

Top Down - Bottom Up

- Specify IB or OB mount and rail color. Middle rail will match the top and bottom rails.
- Specify cord loop length when ordering.
- Controls are the right cord loop operates the middle rail and left cord loop operates the bottom. Reverse controls are not available.

Two-On-One Head Rail

- Two-On-One Head Rail Shades operate as two separate shades on one head rail.
- Specify IB or OB mount and rail color.
- Specify panel sizes.
- Specify cord loop length when ordering.
- 3/8" Space between panels.
- Fabric wrapped Two-On-One Shades will have a seam in the center of the rail due to the wide width.

Ultra Feature:

Ultra - is a synthetic lift cord that allows cordless Color Lux cellular shades to more easily move up and down.

[More information on page 29.](#)

EZ Level on Comfortex Cellular Shades

EZ Level makes quick work of leveling without cords to cut or tuck into a rail. No special tools needed – just use a nickel, quarter or penny to adjust plug on the bottom rail.

EZ Level is standard on all Cellular and Pleated Shades with the following hardware systems:
 Standard Cord Lock, Cordless Ultra, Cord Loop Simplicity Motorized Systems

EZ Level is not available with Cordless Lift & Lock.

How does EZ Level work?

- Slightly raise the bottom rail you want to level.
- Insert a coin or flat head screwdriver into the adjustment screw and turn it.
- Turn the adjustment screw clockwise or counter clockwise to make slight adjustments up or down. One quarter turn of the adjustment screw will move the bottom rail up or down 1/4".
- Lower the rail to check the level and make further adjustments if necessary.



Color Lux® Cellular Shades

CORDLESS ULTRA HARDWARE SYSTEM

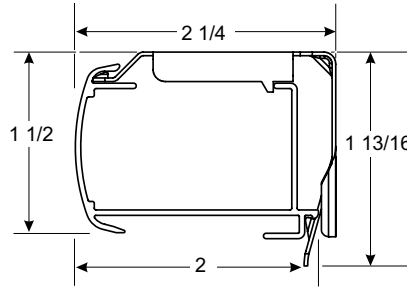
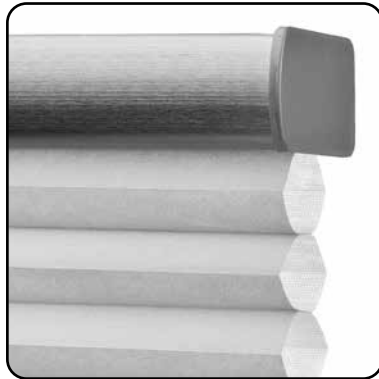

Cordless Rail Dimensions

- Depth of rail: 2"
- Depth of rail and bracket: 2 1/4"
- Height of rail: 1 1/2"
- Height of bracket: 1 13/16"



Clear Cordless Handle

Hardware Features	
Fabric Wrapped	Fabric used is same fabric as the shade. Back of rail is white to outside. Frosted clear with fabric insert end caps with white cord.
Designer Metallic	<ul style="list-style-type: none"> • Oil Rubbed Bronze head and bottom rails with bronze colored end caps and cord.
Mounting Dimensions	
Minimum Shallow Mount	1/2"
Minimum Flush Inside Mount	2 1/4"
Minimum Outside Mount	7/8"
Minimum Side Mount	1 1/4"
Recommended Side Mounting Method	<ul style="list-style-type: none"> • See figure A, page 26 for recommended mounting method for side mount shades • Width limit for side mount brackets is 48"
Finished Dimensions	
Inside Mount	
	<ul style="list-style-type: none"> • Fabric will measure ordered width less: 3/8" • Head rail* will measure ordered width less: 3/16"
Outside Mount	
	<ul style="list-style-type: none"> • Fabric will measure ordered width • Head rail* will measure ordered width plus: 3/16"
Side Mount	
	<ul style="list-style-type: none"> • Fabric will measure ordered width less: 7/8" • Head rail* will measure ordered width less: 1 1/16"
Exact (End Cap to End Cap) Mount	
	<ul style="list-style-type: none"> • Fabric will measure ordered width less: 3/16" • Head rail* will measure ordered width
* Head rail measurements include endcaps. Width and length measurements may vary +/- 1/8"	

Cordless Ultra Feature:

Ultra - is a synthetic lift cord that allows cordless Color Lux cellular shades to more easily move up and down.

Ultra Technology is standard on all Color Lux Cordless Ultra, cord loop, Top Down-Bottom Up, motorized and Lift & Lock shades.

The improved performance - quantified as a 25% reduction in pull force - is made possible by the lift cord's unsurpassed combination of slickness, toughness, and chemical resistance.

These qualities produce noticeably less friction as the lift cord moves, making it easier to raise and lower the shade, while also reducing wear on the shade's components.

Color Lux® Cellular Shades

CORDLESS ULTRA HARDWARE SYSTEM

Applications

- Standard Rectangular
- Top Down - Bottom Up
- Two-On-One Head Rail
- Friction Fit - [See page 46 for details](#)

Things to Consider

- Is the top of your window out of reach? You can order an extension pole to reach but it can still be tricky. You may want to consider Cord Loop or Motorized hardware.
- For shades mounted on doors, you may want to order hold down brackets.
- If privacy is an issue, consider Top Down-Bottom Up options.

Ordering Information for Cordless Ultra Hardware Shades

Standard Rectangular

- Specify IB or OB mount and rail color.

Top Down - Bottom Up

- Specify IB or OB mount and rail color.
 Middle rail will match the head and bottom rails.

Accessories

- 3' Expandable Pole - Silver:
- 5-10' Expandable Pole - Black:

Specially designed pole end fits into the handle on the bottom rail and allows for easy operation.



Note: The pole can not be used to raise only the middle rail on a top down-bottom up shade. If it is necessary to raise the middle rail with a pole, simply push up on the bottom rail so that the bottom and middle rails both raise. Once the middle rail is in the desired position, the pole may be used to lower the bottom rail.

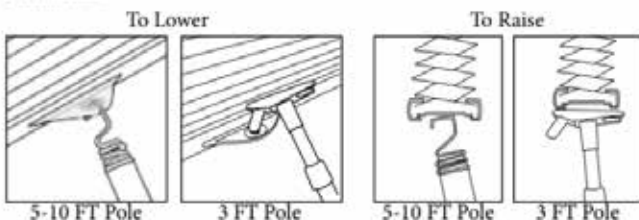

New Sleek 3' Pole

Optional



Cordless Ultra and Cordless Ultra Top Down - Bottom Up Hardware Features

- Children and pets have safer surroundings in homes that have window shades without operating cords, reducing the risk of strangulation.
- Cordless Ultra and Cordless UltraSmooth Top Down - Bottom Up Shades can be raised or lowered with a gentle push or pull on the rail handle.
- Cordless Ultra Top Down - Bottom Up Shades feature two moving rails.
- Order an operating pole for out of reach applications.

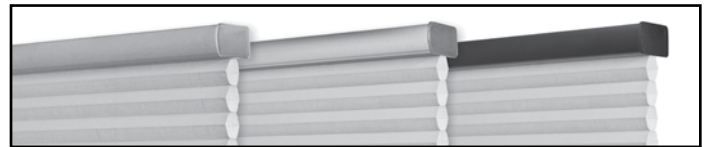

Fabric Wrapped Head Rail and Designer Metallic Head Rails.

Cordless Ultra Shade Operation

Cordless shades should be operated from the handle located in the center of the bottom rail. Using the handle will aid in smooth and easy shade operation. Two handles are supplied on wider width shades.

To lower the shade, pull down on the handle which is secured to the bottom rail and guide the rail to desired position (Figure A). For out of reach applications, an optional extension pole should be used.

To raise the shade, push the bottom rail up using the handle on the bottom rail and guide the rail to the desired position. The shade will hold any position when the bottom rail is released. Raise the shade slowly and steadily to allow the shade to stack evenly (Figure B).

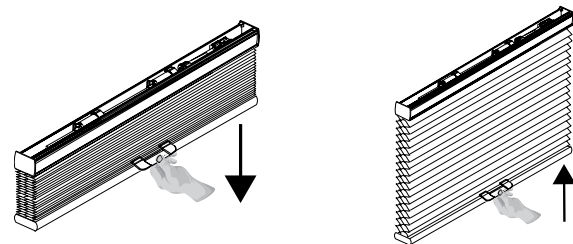

Figure A

Figure B

EZ Level on Cellular Shades

EZ Level makes quick work of leveling without cords to cut or tuck into a rail. See page 72 for details.

Color Lux® Cellular Shades
CORDLESS LIFT & LOCK HARDWARE SYSTEM

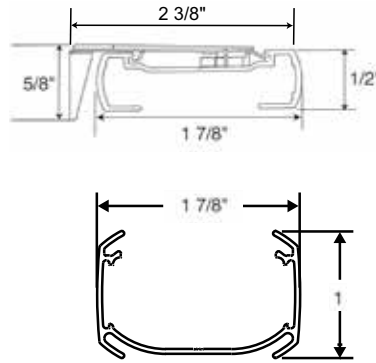

Cordless Lift & Lock Rail

- Depth of rail: 1 7/8"
- Depth of rail and bracket: 2 3/8"
- Height: 1/2"
- Height of bracket: 5/8"

Cordless Lift & Lock Bottom Rail

- Depth of rail: 1 7/8"
- Height: 1 1/8"

Hardware Features	
Hardware	<ul style="list-style-type: none"> • Fabric wrapped head, middle and bottom rails. Shades will have a coordinated or white push button/handle and end caps on the middle/bottom rail. Refer to coordination chart in the Dealer Resource Center in the Fabrication section online. • Fabric used to cover the rails is the same fabric as the shade. The back of the rail will be white to the outside.
Upgrades	
Designer Metallic Upgrade	<ul style="list-style-type: none"> • Smooth faced Designer Oil Rubbed Bronze Metallic head, middle and bottom rail and end caps. • Oil Rubbed Bronze push button/handle on the middle and bottom rails.

Mounting Dimensions	Lift & Lock Head Rail
Minimum Shallow Mount	3/4"
Minimum Flush Inside Mount	2 1/2"
Minimum Outside Mount	3/4"
Minimum Side Mount	1 3/8"
Recommended Side Mounting Method	<ul style="list-style-type: none"> • See figure A (pg 26) for recommended mounting method for side mount shades • Width limit for side mount brackets is 48"

Finished Dimensions	
Inside and Side Mount	
	<ul style="list-style-type: none"> • Fabric will measure ordered width less: 3/8" • Head rail* will measure ordered width less: 3/16"
Outside Mount	
	<ul style="list-style-type: none"> • Fabric will measure ordered width • Head rail* will measure ordered width plus: 3/16"
Exact (End Cap to End Cap) Mount	
	<ul style="list-style-type: none"> • Fabric will measure ordered width less: 3/16" • Head rail* will measure ordered width

* Head rail measurements include endcaps.
Width and length measurements may vary +/- 1/8"

Color Lux® Cellular Shades

CORDLESS LIFT & LOCK HARDWARE SYSTEM

Applications

- Standard Rectangular
- Top Down-Bottom Up
- Two-On-One Head rail
- Friction Fit - [See page 45 for details](#)

Important Operating Note on Cordless Lift & Lock Shades

- To operate a Cordless Lift & Lock Shade, the middle or bottom rails must be accessible. An extension pole is not available for Cordless Lift & Lock Shades.
- If the bottom or middle rail is not accessible, you may want to consider Cord Loop, Cordless Ultra or Motorized hardware. An extension pole is not available for Cordless Lift & Lock Shades.

Cordless Lift & Lock Hardware Features

- Children and pets have safer surroundings in homes that have window shades without operating cords, reducing the risk of strangulation.
- Cordless Lift & Lock Shades can be raised or lowered by pressing the button located on the bottom rail and guiding the rail into the desired location.

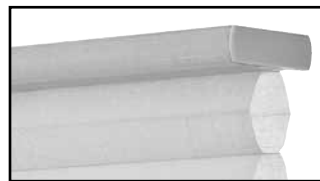

Fabric Wrapped Head Rail with White End Caps



Fabric Wrapped Bottom Rail with White push button/handle



Oil Rubbed Bronze Head Rail and End Caps



Oil Rubbed Bottom Rail and push button/handle

Ordering Information for Cordless Lift & Lock Shades

Standard Rectangular

- Specify IB or OB mount and rail color.

Cordless Lift & Lock Shade Operation

Cordless Lift & Lock Shades are operated using the push button handle located in the center of the bottom rail.

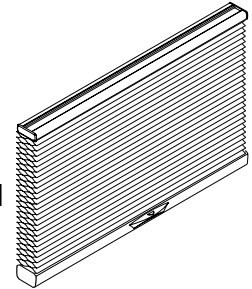

To raise or lower the shade; press the button on the shade handle, and guide the rail to desired position. Release the button to lock the shade into place.

The shade will hold any position when the button is released. Raise the shade slowly and steadily to allow the shade to stack evenly.

Recommended Mounting Method for Side Mounting Shades

See Page 26.

Ultra Feature:

Ultra - is a synthetic lift cord that allows cordless Color Lux cellular shades to more easily move up and down.

[More information on page 29.](#)

NOTE: Lift and Lock shades do not utilize the EZ Level plugs like other Comfortex rectangular shade hardware systems. The bottom rail equalization can be adjusted using the tie-off plugs on the top of the headrail. Middle rail of TDBU has an adjusting tool inside the rail. Access by removing the right side endcap.

Color Lux® Cellular Shades

SIMPLICITY BLUETOOTH MOTORIZATION



PRODUCT	Simplicity PowerTouch	Simplicity Remote	NEO Smart Controller	Simplicity w/ Bluetooth	Rechargeable SOMFY	12v Low Volt Hardwire
Cellular	•	•	•			•
Color Lux Cellular	•		•	•		•
Cellular Top-Down Bottom-Up		•	•			
Color Lux Cellular Top-Down Bottom-Up			•	•		
Mezzo Skylight			•	•		
Mezzo Skylight			•	•		
Color Lux Sheer Shadings	•		•	•		•
Roller - Color Lux	•		•	•		•

Benefits of Simplicity BlueTooth™ Motorization: Featuring the Free Color Lux Mobile App

- New “state of the art” 7.4v rechargeable motorization operates with both BlueTooth and Radio Frequency control technology.
- Download the new Color Lux Mobile Bluetooth App FREE on the Apple App Store for iPhone or the Google Play Store for Android.
- Optional Simplicity radio frequency remote control with choice of 5 channel, 6 channel with timer, or 14 channel remote.
- Optional Simplicity Smart Controller (NEO) for remote operation of shades which integrates with Amazon Alexa and Google Assistant devices.

Features of the Color Lux Mobile Bluetooth App:

- Controls your shade directly from your phone with Bluetooth control.
- Has a shade position display indicator. See screen to the right.
- Has a battery charge level indicator.
- Controls the shade using easy swipe or control buttons.
- Controls up to 5 shades simultaneously and no limit to the number of shades connected to a single account.
- Has timer and scene setting options.

Please Note: There are many factors affecting Bluetooth range

- Physical obstacles in the transmission path
- The antennas should be exposed for best performance
- Bluetooth 4.2 supports 10 meters indoor range (~33 feet).

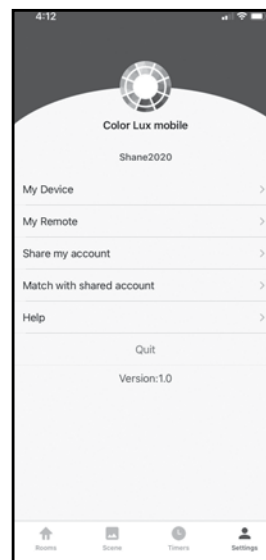

Color Lux Mobile App Main Screen

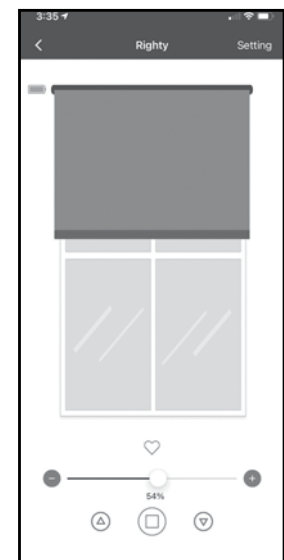

Color Lux Mobile App Control Screen

Cellular Shade Head Rail Options

12V NON-RECHARGEABLE SIMPLICITY MOTORIZED CELLULAR SHADES

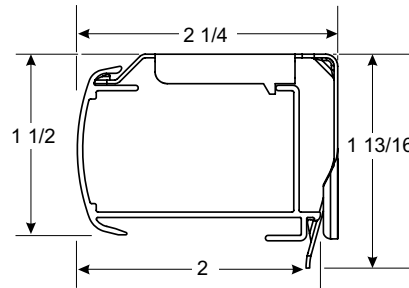

Simplicity Motorized Rail Dimensions

- Depth of rail: 2"
- Depth of rail and bracket: 2 1/4"
- Height of rail: 1 1/2"
- Height of bracket: 1 13/16"

Hardware Features

Standard Hardware	<ul style="list-style-type: none"> • Fabric Wrapped head and bottom rails. Head rail and Bottom rails will have frosted end caps with fabric inserts. • Fabric used to cover the rails is the same fabric as the shade. The back of the rail will be white to the outside.
Simplicity Remote	Upper and lower limit stops pre-programmed, intermediate stop "Favorites" position can be set on site.
Upgrades	
Designer Metallic Upgrade	<ul style="list-style-type: none"> • Smooth faced Designer Oil Rubbed Bronze head, middle, bottom rails and end caps

Mounting Dimensions

Simplicity Motorized Hardware System

Minimum Shallow Mount	1/2"
Minimum Flush Inside Mount	2 1/4"
Minimum Outside Mount	7/8"
Minimum Side Mount	1 1/4"
Recommended Side Mounting Method	<ul style="list-style-type: none"> • See page 26 for recommended mounting method for side mount shades • Width limit for side mount brackets is 48"

Finished Dimensions

Inside Mount	<ul style="list-style-type: none"> • Fabric will measure ordered width less: 3/8" • Head rail* will measure ordered width less: 3/16"
Outside Mount	<ul style="list-style-type: none"> • Fabric will measure ordered width • Head rail* will measure ordered width plus: 3/16"
Side Mount	<ul style="list-style-type: none"> • Fabric will measure ordered width less: 7/8" • Head rail* will measure ordered width less: 1 1/16"
Exact (End Cap to End Cap) Mount	<ul style="list-style-type: none"> • Fabric will measure ordered width less: 3/16" • Head rail* will measure ordered width

* Head rail measurements include endcaps. Width and length measurements may vary +/- 1/8"

Cellular Shade

12V NON-RECHARGEABLE SIMPLICITY MOTORIZED CELLULAR SHADES

Simplicity Motors

The Simplicity Motor program features a battery powered motor utilizing a single battery wand or plug-in DC transformer. Simplicity motors are compact and use a radio frequency remote to raise or lower the shades.

Motorized Lift Systems are not offered on sizes within the shaded area on the Standard Rectangular price grids.

- Length measurements may vary +/- 1/8".

Applications

- Standard Rectangular
- Two-On-One Head Rail
- Friction Fit - See page 46 for details

EZ Level

Learn about the EZ Level feature on page 72.

Simplicity Motorization Surcharges

The standard Simplicity Motorized Lift System surcharge includes a 12 volt battery wand with eight AA batteries. Remotes are needed to operate the shades. See pricing pages.

Important Simplicity Motorized Shade Operating and Installation Information

- Simplicity Motorized Shades installed into windows with metal casings may have a reduced radio frequency range, or may not operate at all, depending on the application.
- Do not let the antenna on the motor touch any metal objects. This may interfere with signals from the remote control.

NEW Simplicity Bluetooth Motorization

Learn about Simplicity Bluetooth motorization and Comfortex FREE Color Lux Mobile App on page 33.

Simplicity Battery Wand

Batteries are needed to operate Simplicity motors. The battery wand can be clipped to the head rail or wall or ceiling mounted utilizing white battery wand clips. The 12 volt battery wand measures 17 1/4", and comes with eight AA alkaline batteries, and is white in color.

The battery wire is 10" long. A 48" extension wire is available.



Simplicity Motor Battery Life and Replacement

Eight alkaline batteries are included with the wand.

The battery life will vary based on the type of window covering selected, the size and weight of the window covering and the number of times you operate the shade on a daily basis. For example, a 36" x 60" single honeycomb shade operated twice daily will commonly have a battery life which lasts up to 18 months.

Comfortex will warranty batteries for up to 3 months from date of purchase.

Simplicity Hand Held Remote 14 Channel Remote

The TDBU remote has 14-channels. This remote is required for TDBU motorization but can be utilized on all Simplicity motorized shades. Each channel has a setting to operate the middle rail and a setting to operate the bottom rail. The TDBU remote is required for TDBU motors. The **14 Channel TDBU remote** can operate up to fourteen shades individually or 14 groups. Simplicity Rechargeable Motorized Cellular Shades are programmed at the factory with the "up and down" limits. The shades are **UNLINKED** from the remote so they are not able to operate during shipping. Each shade should be installed **after** linking it to the remote.



Simplicity TDBU remotes and holders are white or black in color. The remote comes with a holder which can be mounted to a wall for easy storage. The range of the remote is approximately 80 feet.

DC Power Supply/Transformer

12 Volt DC power supply/transformer is available and requires a standard power outlet to power the motor. The transformer is an alternative to a battery wand. Each transformer can power a single shading. The power supply must plug in to the motor. The DC power supply is black and comes with a 80" wire. The dimensions are 1 7/8" wide x 3 1/4" long x 1 1/4" deep



SIMPLICITY MOTORIZATION PRICING EXAMPLE:

Linen Weave	
Light Filtering 42" x 60" Shade:	\$611.00
Simplicity Motor Surcharge:	\$300.00
14 Channel Remote Control:	\$50.00
Total List Price:	\$961.00

Color Lux® Cellular Shades

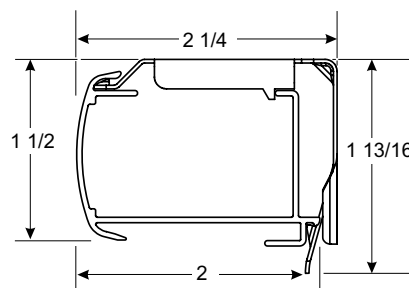
7.4V RECHARGEABLE SIMPLICITY HARDWARE SYSTEM
WITH QUIETUDE™ TECHNOLOGY**Simplicity Rechargeable Rail Dimensions**

- Depth of rail: 2"
- Depth of rail and bracket: 2 1/4"
- Height of rail: 1 1/2"
- Height of bracket: 1 13/16"

Hardware Features

Standard Hardware	<ul style="list-style-type: none"> • Fabric Wrapped head and bottom rails. Head rail and Bottom rails will have frosted end caps with fabric inserts. • Fabric used to cover the rails is the same fabric as the shade. The back of the rail will be white to the outside.
Simplicity Remote	Upper and lower limit stops pre-programmed, intermediate stop "Favorites" position can be set on site.
Upgrades	
Designer Metallic Upgrade	<ul style="list-style-type: none"> • Smooth faced Designer Oil Rubbed Bronze head, middle, bottom rails and end caps

Mounting Dimensions**Simplicity Rechargeable Motorization Hardware System**

Minimum Shallow Mount	1/2"
Minimum Flush Inside Mount	2 1/4"
Minimum Outside Mount	7/8"
Minimum Side Mount	1 1/4"
Recommended Side Mounting Method	<ul style="list-style-type: none"> • See page 26 for recommended mounting method for side mount shades • Width limit for side mount brackets is 48"

Finished Dimensions**Inside Mount**

- Fabric will measure ordered width less: 3/8"
- Head rail* will measure ordered width less: 3/16"

Outside Mount

- Fabric will measure ordered width
- Head rail* will measure ordered width plus: 3/16"

Side Mount

- Fabric will measure ordered width less: 7/8"
- Head rail* will measure ordered width less: 1 1/16"

Exact (End Cap to End Cap) Mount

- Fabric will measure ordered width less: 3/16"
- Head rail* will measure ordered width

* Head rail measurements include endcaps. Width and length measurements may vary +/- 1/6"

Ultra Feature:

Ultra - is a synthetic lift cord that allows cordless Color Lux cellular shades to more easily move up and down.

[More information on page 29.](#)

Color Lux® Cellular Shades

7.4V RECHARGEABLE SIMPLICITY HARDWARE SYSTEM WITH QUIETUDE™ TECHNOLOGY



Bluetooth Rechargeable Simplicity Motors

The Simplicity Motor program features a battery powered motor utilizing a rechargeable battery hidden inside the shade head rail. New "state of the art" 7.4v rechargeable motorization operates with both BlueTooth and Radio Frequency control technology.

Rechargeable Motorized Lift Systems are not offered on sizes within the shaded area on the Standard Rectangular price grids.

Applications

- Standard Rectangular
- Friction Fit - [See page 46 for details](#)

Please Note

- Motorized shades less than 24" in width are limited to a maximum of 60" in length.

EZ Level

Learn about the EZ Level feature on page 72.

Rechargeable Simplicity Motorization Surcharges

The Rechargeable Simplicity Motorized Lift System surcharge includes a rechargeable battery. Remotes are needed to operate the shades. Refer to pricing pages.

Front Access Control

All Color Lux Cellular Shades with Rechargeable Simplicity motors come with a front-facing, flip-top cover for convenient access to the charging port, reset button, and on/off switch.

Shades with front control access include an auxiliary charging port in the back. This port is ideal for a solar panel charging kit or for shades where a top treatment may limit access to the front-side port.

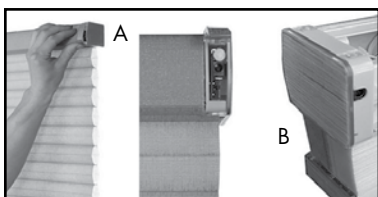

A) Front Control
B) Back of Head rail.

Simplicity Rechargeable Battery

The rechargeable battery is concealed in the head rail of the shade. A charger is required for the rechargeable battery. The rechargeable battery comes fully charged from the factory.

SIMPLICITY RECHARGEABLE BATTERY WAND
PRICING EXAMPLE: Page 8

Solar Panel Recharge Option

Plugs in to any Simplicity Rechargeable Remote control shade (does not work with PowerTouch)

Provides constant trickle charge to 7.4v Li-Ion Rechargeable battery packs. Will prolong the life of the charge of the 7.4v rechargeable battery packs, and in some applications will maintain charge indefinitely.

Life of charge is subject to application variables such as, size and weight of shade, frequency of use, amount of direct sunlight exposure, etc.

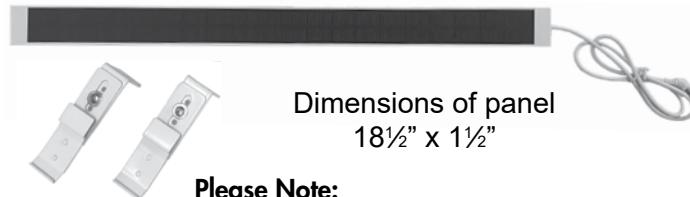

Dimensions of panel
18½" x 1½"

Please Note:

LED solar panel cord length is 24". Make sure to order 48" extension cord if needed.

Solar Recharge Optimum Application

- Full direct sunlight (minimum 2 hours per day) to maintain full charge. Based on one operation cycle per day (one open, one close).
- Excessive duration of cloudy weather will impact the rate of charge.

Solar Panel LED Lights

Red Light: Indicates optimum direct sun exposure

Green Light: Indicates sunlight is enough to charge battery

Blue Light: Indicates battery is charging. Blue light is off when not charging (including when the battery is full)

No Lights: Night or very low sun

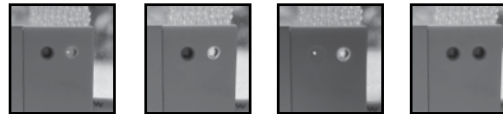

Red Light Green Light Blue Light No Light

Solar Panel Mounting

Bottom portion of the bracket may be lowered if needed for more sun exposure. Bracket can be mounted behind or next to shade mounting bracket.

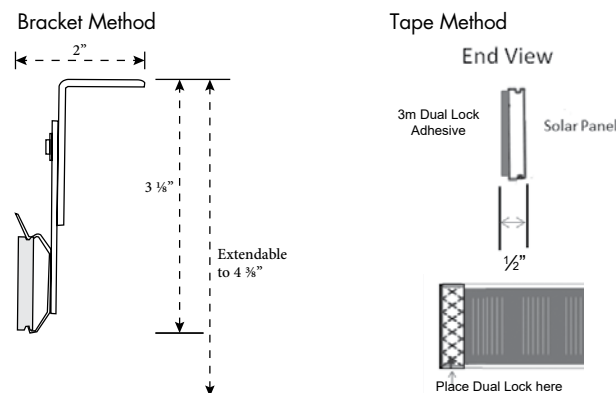

Tape goes on the face (black side) of the panel.

If the solar panel is mounted directly behind the headrail at the top of the window, you need to make sure that the solar panel does not interfere with the shade mounting brackets. The solar panel can go between brackets spaced apart, or behind brackets if the depth of the window casing allows.

Color Lux® Cellular Shades

7.4V RECHARGEABLE SIMPLICITY HARDWARE SYSTEM

WITH QUIETUDE™ TECHNOLOGY



Bluetooth Simplicity Rechargeable Battery Life

Rechargeable batteries are included with the motor.

The average battery charge will last 6-12 months based on an average sized shade raised and lowered once per day. The life of the battery charge will vary based on the type of window covering selected, the size and weight of the window covering and the number of times the shade is operated on a daily basis.

The battery can be recharged up to 500 times. It takes approximately 5 hours to recharge the motor when fully depleted.

Ordering Information for Rechargeable Motorized Cellular Shades

Simplicity Motor Option

- Specify IB or OB mount and rail color.
- Specify remote and other accessories if needed.
- Specify one or more battery chargers.

Please Note:

- Not all motors run at the same rate of speed.
- Simplicity motors have a "Favorites" position setting. If the homeowner wants to set several shades at the same intermediate position, follow instructions provided with installation manual.
- Simplicity Rechargeable Motorized Cellular Shades are programmed at the factory with the "up and down" limits. The shades are **UNLINKED** from the remote so they are not able to operate during shipping. Each shade should be installed **before** linking it to the remote.
- **REMEMBER: Order at least one charger if ordering rechargeable motors.**

Important Simplicity Motorized Shade Operating and Installation Information

Simplicity Motorized Shades installed into windows with metal casings may have a reduced radio frequency range, or may not operate at all, depending on the application.

Do not let the antenna on the motor touch any metal objects. This may interfere with signals from the remote control.

Simplicity Motorized Shade Warranty

Please see Policy PDF for complete Comfortex warranty information.

Battery Charger

8.4 Volt charger requires a standard power outlet to recharge the battery. You must specify charger when ordering a Simplicity Rechargeable Shade. The charger plugs into the charger port. The charger is black and comes with a 156" (13') wire. The dimensions are 1" wide x 2½" length x 1¾" deep.



Simplicity Hand Held Remote

14 Channel Remote

The TDBU remote has 14-channels. This remote is required for TDBU motorization but can be utilized on all Simplicity motorized shades. Each channel has a setting to operate the middle rail and a setting to operate the bottom rail. The TDBU remote is required for TDBU motors. The **14 Channel TDBU remote** can operate up to fourteen shades individually or 14 groups. Simplicity Rechargeable Motorized Cellular Shades are programmed at the factory with the "up and down" limits. The shades are **UNLINKED** from the remote so they are not able to operate during shipping. Each shade should be installed **after** linking it to the remote.



Simplicity TDBU remotes and holders are white or black in color. The remote comes with a holder which can be mounted to a wall for easy storage. The range of the remote is approximately 80 feet.

Simplicity Motor Hand Held Remotes Operation

Press the up or down button on the remote to raise or lower the shade to your desired position.

To reprogram channel assignments, please refer to the installation instructions and/or view the video at: comfortex.com/comfortex-dealers.

The Simplicity remotes utilize one 3V battery. Batteries are included. Comfortex will warranty batteries for up to 3 months from date of purchase. Batteries are not covered by the warranty.

NEW Simplicity Bluetooth Motorization

Learn about Simplicity Bluetooth motorization and Comfortex FREE Color Lux Mobile App on page 33.

Color Lux® Cellular Shades

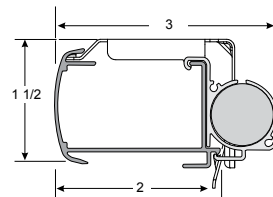
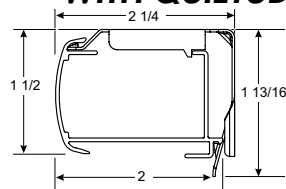
7.4V RECHARGEABLE MOTORIZED TOP DOWN-BOTTOM UP
WITH QUIETUDE™ TECHNOLOGY**Simplicity Motorized Rail Dimensions**

- Depth of rail: 2"
- Depth of rail and bracket: 2 1/4"
- Height of rail: 1 1/2"
- Height of bracket: 1 13/16"

Simplicity Motorized Rail with External Battery Dimensions (for shades 36" wide and under)

- Depth of rail: 2"
- Depth of rail, bracket & battery: 3"
- Height of rail: 1 1/2"
- Height of bracket: 1 13/16"

Hardware Features

Standard Hardware	<ul style="list-style-type: none"> • Fabric Wrapped head, middle and bottom rails. Head rail and Bottom rails will have frosted end caps with fabric inserts. • Fabric used to cover the rails is the same fabric as the shade. The back of the rail will be white to the outside.
TDBU 14 Channel Remote	Upper and lower limit stops pre-programmed.
Upgrades	
Designer Metallic Upgrade	<ul style="list-style-type: none"> • Smooth faced Designer Oil Rubbed Bronze head, middle, bottom rails and end caps

Mounting Dimensions**Simplicity Motorized Hardware System**

Minimum Shallow Mount	1/2"
Minimum Flush Inside Mount	2 1/4"
Minimum Outside Mount	7/8"
Minimum Side Mount	1 1/4"
Recommended Side Mounting Method	<ul style="list-style-type: none"> • See page 26 for recommended mounting method for side mount shades • Width limit for side mount brackets is 48"

Finished Dimensions**Inside Mount**

- Fabric will measure ordered width less: 3/8"
- Head rail* will measure ordered width less: 3/16"

Outside Mount

- Fabric will measure ordered width
- Head rail* will measure ordered width plus: 3/16"

Side Mount

- Fabric will measure ordered width less: 7/8"
- Head rail* will measure ordered width less: 1 1/16"

Exact (End Cap to End Cap) Mount

- Fabric will measure ordered width less: 3/16"
- Head rail* will measure ordered width

* Head rail measurements include endcaps. Width and length measurements may vary +/- 1/8"

Color Lux® Cellular Shades

7.4V RECHARGEABLE MOTORIZED TOP DOWN-BOTTOM UP WITH QUIETUDE™ TECHNOLOGY



Bluetooth Simplicity Rechargeable Motors

The Simplicity Motor program features a battery powered motor utilizing a rechargeable battery hidden inside the shade head rail. If shades are 36" or less in width, an external snap-on battery pack is necessary. (See page 129)

Applications

- Rectangular
- Friction Fit - See page 46 for details

EZ Level

Learn about the EZ Level feature on page 72.

Rechargeable Simplicity Motorization Surcharges

The Rechargeable Simplicity Motorized Lift System surcharge includes a rechargeable battery. 14 channel remotes are needed to operate the shades. Refer to pricing pages.

Ordering Information for Top Down-Bottom Up Motorized Cellular Shades

Simplicity Motor Option

- Specify IB or OB mount and rail color.
- 14 Channel TDBU Remote is required.
- Specify one or more battery chargers.

Please Note:

- Shades that are 24"-36" in width will have an external battery.
- Shades with an external battery and OB mounted will need spacer blocks.
- Simplicity Rechargeable Motorized Cellular Shades are programmed at the factory with the "up and down" limits set on both moving rails.
- **REMEMBER: Order at least one charger if ordering rechargeable motors.**

Top Down-Bottom Up Simplicity Motor Hand Held 14 Channel Remote

The TDBU remote has 14-channels. Each channel has a setting to operate the middle rail and a setting to operate the bottom rail. The TDBU remote is required for TDBU motors. The **14 Channel TDBU remote** can operate up to fourteen shades individually or 14 groups. Simplicity Rechargeable Motorized Cellular Shades are programmed at the factory with the "up and down" limits. The shades are **UNLINKED** from the remote so they are not able to operate during shipping. Each shade should be installed **after** linking it to the remote.



Simplicity TDBU remotes and holders are white in color. The remote comes with a holder which can be mounted to a wall for easy storage. The range of the remote is approximately 80 feet.

Front Access Control

All Color Lux Cellular Shades with Rechargeable Simplicity motors come with a front-facing, flip-top cover for convenient access to the charging port, reset button, and on/off switch.

Shades with front control access include an auxiliary charging port in the back. This port is ideal for a solar panel charging kit or for shades where a top treatment may limit access to the front-side port.

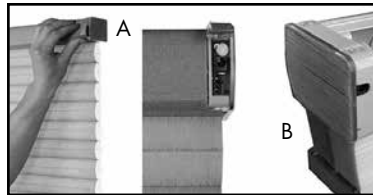

A) Front Control

B) Back of Head rail.

Simplicity Rechargeable Battery

The rechargeable battery is concealed in the head rail of the shade. A charger is required for the rechargeable battery. The rechargeable battery comes fully charged from the factory.

Battery Charger

8.4 Volt charger requires a standard power outlet to recharge the battery. You must specify charger when ordering a Simplicity Rechargeable shade. The charger plugs into the charger port. The charger is black and comes with a 156" (13') wire. The dimensions are 1" wide x 2½" length x 1¼" deep.



Solar Panel Recharge Option

Learn about the Solar Panel on page 37.

NEW Simplicity Bluetooth Motorization

Learn about Simplicity Bluetooth motorization and Comfortex FREE Color Lux Mobile App on page 33.

MOTORIZED TOP DOWN-BOTTOM UP PRICING EXAMPLE:

Linen Weave	
Light Filtering 42" x 60" Shade:	\$611.00
Simplicity Rechargeable Surcharge:	\$515.00
Charger for Rechargeable:	\$30.00
TDBU Remote Control:	\$50.00
Total List Price:	\$1206.00

Ultra Feature:

Ultra - is a synthetic lift cord that allows cordless Color Lux cellular shades to more easily move up and down.

[More information on page 29.](#)

Color Lux® Cellular Shades

7.4V EZ CHARGE EXTENSION WAND

EZ Charge Extension Wand Option

EZ Charge Extension Wand is the newest innovation in rechargeable motorization. Easily charge your hard to reach Simplicity Rechargeable Shades with the EZ Charge Extension Wand. The wand extends up to 31" in length.

Simple to use! Place the magnetized wand tip on the receiving port to attach. Then plug the charger into the base of the wand. It is that simple!

- EZ Charge Extension Wand can be easily concealed by a valance or drapery panel.
- Great for out of reach windows

EZ Charge Wall Mount Receiver

- The EZ Charge Wall Mount Receiver includes screws and anchors. These can be used for wood or drywall mounting.
- Extension cable plugs into charging port of Simplicity Rechargeable shades.

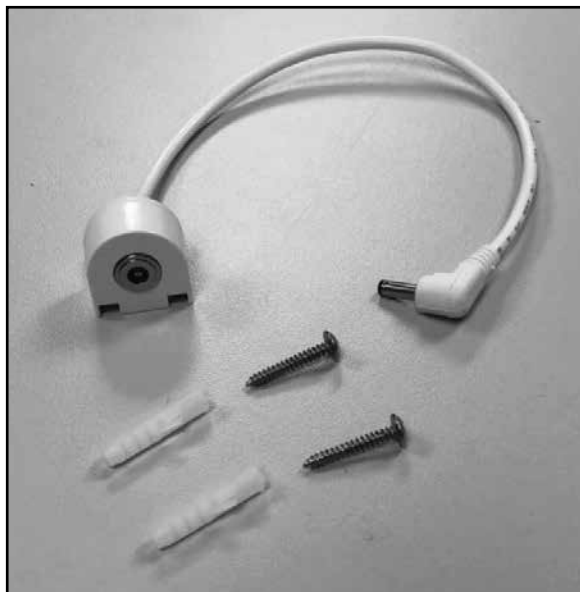

EZ Charge Wall Mount Receiver Kit | CKIT078
 One kit per Simplicity Motorized shade is needed.

Ultra Feature:

Ultra - is a synthetic lift cord that allows cordless Color Lux cellular shades to more easily move up and down.

[More information on page 29.](#)

EZ Charge Wand

- Wand is 9½" and extends to 31"
 Magnetized tip makes connection quick and easy.
- Once wand is in place plug the 8.4v charger into the bottom of the extension wand for charging.

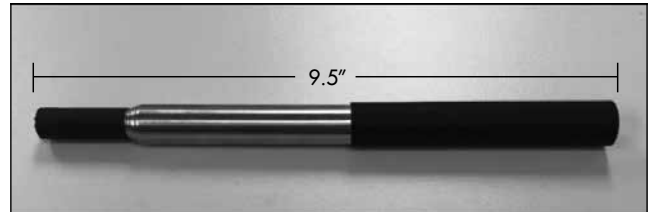

EZ Charge Wand | CKIT077
 Order with the EZ Charge Wall Mount Receiver Kit



EZ Charge Receiving Port



Port/Wand Connection

Shade/Blind Product	EZ Charge Wall Mount Receiver List Price	EZ Charge Wand List Price
Cellular	\$18	\$32



Battery Charger



Wand Base

Battery Charger - SOLD SEPARATELY

You must specify charger when ordering a Simplicity Rechargeable Motorized Shade. The charger plugs into the wand base. The 8.4 Volt charger requires a standard power outlet to recharge the motor. The charger is black and comes with a 156" wire. The dimensions are 1" wide x 2½" length x 1¾" deep.

Cellular Shade Collection

12V SIMPLICITY LOW VOLTAGE HARDWIRING SYSTEM

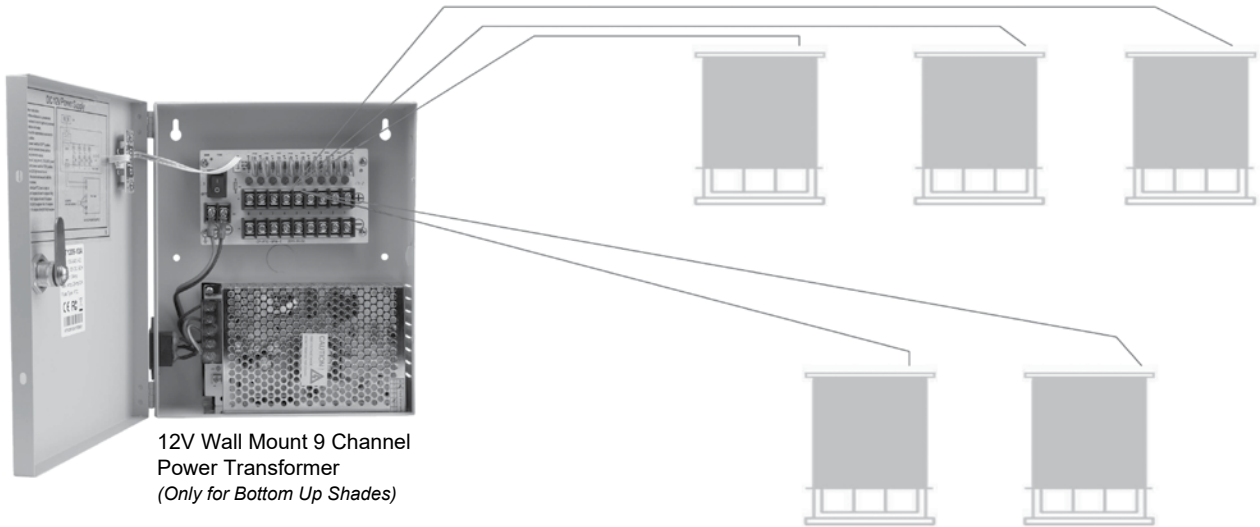

12V Low Voltage Hard Wired

Low Voltage hardwire powered motors are available for Roller Shades, Sheer Shadings and Cellular bottom up shades. The system offers a maintenance-free power option for Simplicity Motorized Shades. Our Simplicity power transformer mounts in a safe dry location (such as your basement), out of sight, and provides power for up to nine individual shades per box.

2 Conductor wires should be pre-installed by a licensed contractor according to local building codes, to connect power from the transformer to the shades.

Simply use the wire adapters provided to connect the power wire to the Simplicity motor power input on the back of the shade, then connect the pre-run wires to the (+ / -) terminal block in the transformer box, and flip on the power switch.

- Product Dimension: 7.875" wide, 9.4" Tall, 2.45" deep
- Converts incoming 120V AC to outgoing 12V for up to 9 shades.

- **Product Description:**

- 12v10a 9ch
- Input Voltage Range : AC90V-264V
- Input Frequency Range : 50Hz-60Hz
- Output Voltage Range : DC12V+/-5%
- Output Current : 10 Ampere
- Output Power : 120 Watt
- Output Ripple&Noise : ≤42MV
- Output Efficiency : ≥83%
- Output Fuse Type : PTC
- Output Fuse Rating : 2A
- Environment Operating Amb.Temp : -30 ~45
20%~90%RH
- Environment Storage Temp : -40 ~85 10%~95%RH
- Plugs into standard household outlet
- Power cord is 56" in length

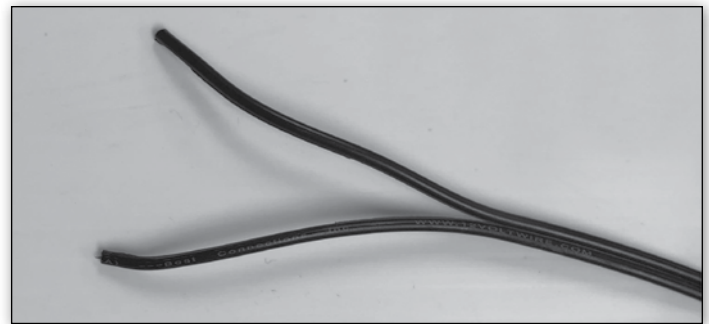

2 Conductor Wires running to basement 12V Power Transformer

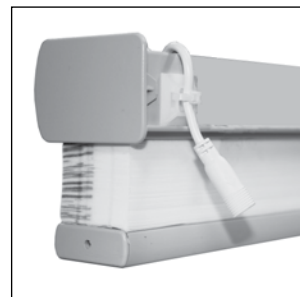

Power port on back of shade

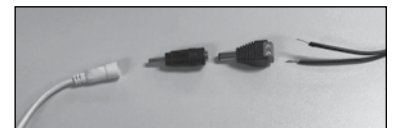

Wires connecting to charging port on Simplicity shade



12V Wall Mount 9 Channel Power Transformer

Color Lux® Cellular Shades

SIMPLICITY SMART CONTROLLER



Simplicity Smart Controller Dimensions

- Width of controller: 2³/₈"
- Length of controller: 2⁵/₁₆"
- Height of controller: 1¹/₈"

Simplicity Smart Controller

- Works with Apple and Android devices
- FREE Downloadable Application
- Compatible with previously installed Simplicity Remote Control Shades
- Powered by NEO Smart Blinds App
- Compatible with Amazon Alexa, Google Assistant systems, Control4 and Savant systems

Simplicity Smart Controller

The Simplicity Smart Controller is a small device that you install in your home that allows you to set automatic opening and closing times for all Simplicity motorized shades as well as the ability to control your motorized shades from a phone, tablet or PC from anywhere in world.

The Simplicity Smart Controller will work with any Comfortex remote motorized shade with Simplicity remote control motors purchased after 2012.

The Simplicity Smart Controller plugs into a standard electrical outlet and connects to WiFi and sends signals to your shades using the same radio frequencies as a normal remote control.

How Does The NEO Smart Blinds App Work?

The app uses WiFi or cellular data to send commands over the internet to the Simplicity Smart Controller.

Do I Need Any Other Equipment?

Yes, The location where your shades are installed must have WiFi in order for the Simplicity Smart Controller to work. Additionally, you must have a smartphone or tablet running Android or iOS (eg. iPhone, iPad, Samsung Galaxy S7) and have the NEO Smart Blinds app. installed.

Why Would I Want A Simplicity Smart Controller?

There are two main ways the Simplicity Smart Controller adds additional value to your motorized shades. First, once all of your shades have been added, you can use your smartphone as a single remote for all of your shades that will work anywhere you are regardless of distance from the shade. Secondly, the device allows you to set schedules so your motorized shades automatically open and close without needing to do anything on a day to day basis.

Do I Need To Buy More Than 1 Controller?

The normal use for the Simplicity Smart Controller is to plug it in out of the way and forget it. Since it has roughly the same range as a remote you will want enough devices to allow all shades to be operated without moving the controller. So depending on the layout of the home and location of the shade, you might want multiple devices to have convenient full home coverage.

How Far Is The Range Of A Controller?

You should see a range of approximately 150 ft. However this number might be less depending on the layout of your home. In general we recommend one per a floor of a normal sized home.

Can I Control My Shades From Multiple Devices?

Yes! You can download the NEO Smart Blinds App onto multiple devices, After installing the App. on a new device simply log in with the same email/password on each device and you will have access to control your shades.

Can It Be Used With Already Installed Shades?

Yes! Simply follow the directions in the NEO Smart Blinds app. to add a shade. At the pairing step you can put the shade in pairing mode using the primary remote control (or by accessing the button on the shades motor). Adding the shade to the NEO Smart Blinds App. will not affect the normal remote operation.

How Much Does The NEO Smart Blinds App Cost?

The App is a free download, However you must have at least one Simplicity Smart Controller to serve as a bridge between the App and your shades.

Color Lux® Cellular Shades

7.4V RECHARGEABLE POWERTOCH MOTORIZED HARDWARE SYSTEM

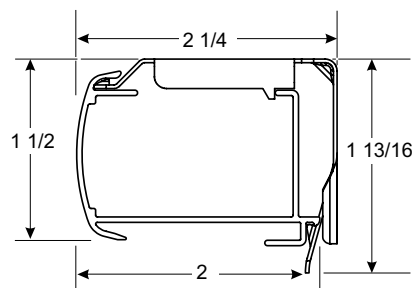
**Simplicity Motorized Rail Dimensions**

- Depth of rail: 2"
- Depth of rail and bracket: 2 1/4"
- Height of rail: 1 1/2"
- Height of bracket: 1 13/16"

Hardware Features

Standard Hardware	<ul style="list-style-type: none"> • Fabric Wrapped head and bottom rails. Head rail and Bottom rails will have frosted end caps with fabric inserts. • Fabric used to cover the rails is the same fabric as the shade. The back of the rail will be white to the outside.
Simplicity Remote	Upper and lower limit stops pre-programmed, Intermediate stop "favorites" position can be set on site.
Upgrades	
Designer Metallic Upgrade	<ul style="list-style-type: none"> • Smooth faced Designer Oil Rubbed Bronze head, middle, bottom rails and end caps

Mounting Dimensions**Simplicity Motorized Hardware System**

Minimum Shallow Mount	1/2"
Minimum Flush Inside Mount	2 1/4"
Minimum Outside Mount	7/8"
Minimum Side Mount	1 1/4"
Recommended Side Mounting Method	<ul style="list-style-type: none"> • See page 26 for recommended mounting method for side mount shades • Width limit for side mount brackets is 48"

Finished Dimensions**Inside Mount**

- Fabric will measure ordered width less: 3/8"
- Head rail* will measure ordered width less: 3/16"

Outside Mount

- Fabric will measure ordered width
- Head rail* will measure ordered width plus: 3/16"

Side Mount

- Fabric will measure ordered width less: 7/8"
- Head rail* will measure ordered width less: 1 1/16"

Exact (End Cap to End Cap) Mount

- Fabric will measure ordered width less: 3/16"
- Head rail* will measure ordered width

* Head rail measurements include endcaps. Width and length measurements may vary +/- 1/8"

Color Lux® Cellular Shades

7.4V RECHARGEABLE POWERTOUCH MOTORIZED HARDWARE SYSTEM

PowerTouch™ Rechargeable Shades

Cellular Shades can be fabricated with the PowerTouch Rechargeable Push Button Control option. The PowerTouch Rechargeable option is an easy, cord free motorized operation for the budget savvy homeowner. PowerTouch Rechargeable uses Simplicity motors and components.

PowerTouch Rechargeable Shades Operation

Press the up or down button on the pendant to raise or lower the shading to your desired position.

No programming is required with PowerTouch™, all programming is set at the factory. Upper and lower limits easily can be adjusted in the field if desired. Please refer to the installation instructions at comfortex.com/comfortex-dealers. A "favorites" or intermediate stop position can be set once installed.

PowerTouch Rechargeable Surcharges

[See page 9.](#)

PowerTouch Appearance

- The PowerTouch wand and pendant is attached to the head rail when installed.
- The wand and pendant hangs down the front of the shades from the head rail. The wand does not touch the fabric.
- Pendant is 2½" long.
- The pendant does not need to be mounted to the wall to operate the shade.



PowerTouch Rechargeable Color Options

- Shades with Black or Oil Rubbed Bronze hardware will be built with black wand and pendants standard. All other colors will use white wand and pendants.

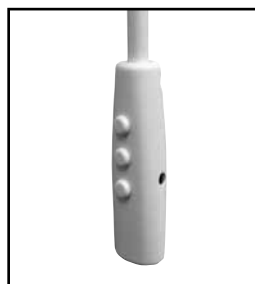

White



Black Shown with Plug-In Charger

PowerTouch Wand and Pendant Location

The standard location for the wand and pendant is on the right. Please specify location when ordering.

PowerTouch Rechargeable Wand Length

- The standard length of the wand will measure the indicated below unless otherwise specified.

Shading Length	Standard Wand Length
Up to 30"	1' (12")
>30" to 52"	2' (24")
>52" to 78"	3' (36")
>78" to 100"	4' (48")
>100" to 120"	5' (60")

Mounting Requirements for PowerTouch Rechargeable Shades

- No special installation hardware or wiring requirements are needed.

Battery Charger

8.4 Volt charger requires a standard power outlet to recharge the battery. You must specify charger when ordering a Simplicity Rechargeable Shade. The charger plugs into the charger port. The charger is black and comes with a 156" wire. The dimensions are 1" wide x 2½" length x 1¾" deep.



PowerTouch Rechargeable Shades Warranty

Please see Policy PDF for complete warranty information.

Ultra Feature:

Ultra - is a synthetic lift cord that allows cordless Color Lux cellular shades to more easily move up and down.

[More information on page 29.](#)

Color Lux® Cellular Shades

FRICITION FIT MOUNTING HARDWARE SYSTEM

FRICITION FIT MOUNTING SYSTEM

The Friction Fit Mounting System is the perfect solution for hard to drill materials and where drilling is not desired or allowed. There is **NO BRACKET INSTALLATION REQUIRED**.

This pressure mounted system utilizes an aluminum rail designed with a high tension spring that is pre-fabricated with your ordered shade. **INSTALLATION BRACKETS** for your ordered shade **ARE PRE-ATTACHED AT THE FACTORY** for easy installation on site.



White Friction Fit Rail

To install, simply insert the Friction Fit rail within the window opening and secure the lever. This increases the pressure to the ends of the rail, allowing for a snug fit in the window opening.

Friction Fit Surcharge: \$93

Friction Fit is ideal for many applications, such as:

- Brick
- Concrete
- Cinderblock
- Steel*
- Aluminum*
- Tile*
- Popcorn and other textured finishes
- Wood

* Smooth surfaces will require use of included double-sided adhesive.

LEVER LOCATION

The lever will always be on the right side of head rail.

SHADE SPECIFICATIONS

- Minimum mounting depth is 2 1/8".
- Maximum width and length for all mounting systems is 84".
- Available with all fabric styles but limited in sizes and mounting systems.
- Friction Fit is not available for sizes in the shaded area on price grids.

OPERATION TYPES *Inside Mount Only*

- Motorization (Rechargeable, Non-Rechargeable, PowerTouch and Hardwired)~
- Cordless Ultra, including Top Down-Bottom Up
- Lift & Lock, including Top Down-Bottom Up

~ Not available on motorized Top Down-Bottom Up shades less than 36" wide.

~ External battery wands for non-rechargeable motorized shades can not be mounted to back of the shade head rail.

COLOR OPTIONS

Friction Fit Mounting System is available in white and black.



White Rail



Black Rail

RAIL PROJECTIONS WITH OPERATING SYSTEMS

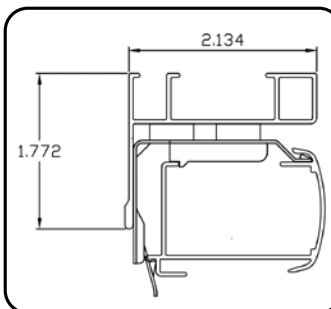

Global Rail End View

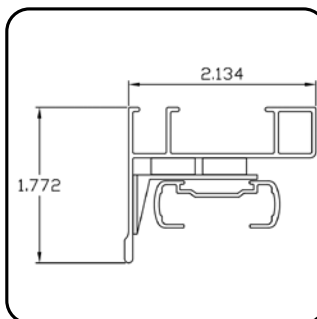

Universal Rail End View

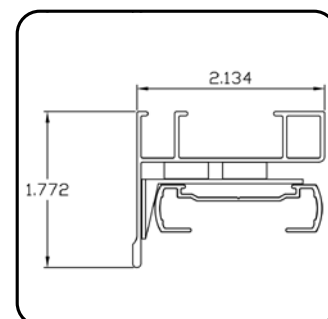

Universal Deluxe Rail End View

Color Lux® Cellular Shades
OVATION CELLULAR SLIDER HARDWARE SYSTEM

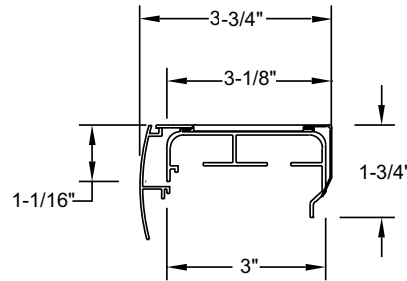

Ovation Hardware Rail Dimensions

- Depth of rail: 3"
- Depth of rail and bracket: 3 1/8"
- Depth of rail, bracket & valance: 3 3/4"
- Height: 1 3/4"

Hardware Features	
Standard Hardware Color	Aspen White #785
Optional Hardware Colors	Visit comfortex.com to view color options <ul style="list-style-type: none"> • Gardenia White #862 • White Tierra #661 • Silverado #276
Mounting Dimensions	
	Ovation Hardware System
Minimum Inside Mount	3/4"
Minimum Flush Mount	3 5/8"
Minimum Outside Mount	5/8"
Finished Dimensions	
Inside Flush Mount	
Track Width:	
Right or Left Stack	3/16" less than ordered width
Split Stack	3/16" less than ordered width
Center Stack	3/16" less than ordered width
Finished Slider Length	1/2" less than ordered width
Valance	3/16" less than ordered width
Outside Mount	
Track Width	Ordered width
Finished Slider Length	Ordered length - No reductions will be made
Valance	Ordered width plus 1 1/4"
Valance Returns	Will measure 3 1/8" (standard)

Color Lux® Cellular Shades

OVATION CELLULAR SLIDER HARDWARE SYSTEM

Applications

- Standard Rectangular
- Opens and closes from side to side
- Four stacking options - see below.
- Dual Panel option with a center opening design with two fabrics, one on each side, each spanning the width of the window.

Ovation Stacking Options

Specify stacking configuration when ordering.

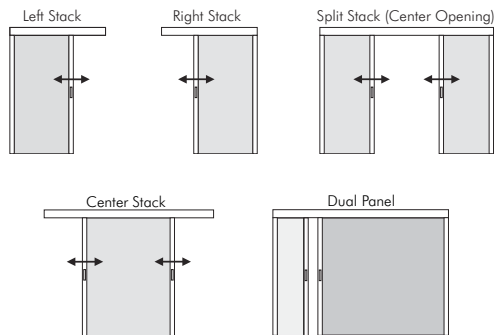

Left: Fabric stacks to the left side of the slider.

Right: Fabric stacks to the right side of the slider.

Center Stack: Center Stack Sliders fabric panels can move fully to the left or the right.

Split Stack: Fabric is split in the center of the slider forming two equal panels which open to opposite ends of the slider. Both panels will be of equal width unless otherwise specified. Split stack is not available with Gradient shades.

* Split stack sliders are available in maximum widths from 240" to 336" (maximum width depends on the fabric selected). If the width exceeds the maximum width of the fabric, it will be fabricated as two separate sliders. The supplied valance will create the appearance of a single slider.

Dual Panel: A Dual Panel Stack Slider has a center opening design with a different fabric on each side, each of which can span the full width of the window. Both panels will be of equal width unless otherwise specified. Specify which fabric stacks to left and which fabric stacks to the right.

Ordering Information for Ovation Cellular Sliders

- Specify IB or OB mount.
- Specify stacking configuration.
 On Dual Panel Shades, specify which fabric stacks to the left and right.
 On Split Stack Shades, both panels will be of equal width unless specified.
- Specify valance width and return length.

Ovation Valance Specifications

- Every Ovation Slider is supplied with a painted aluminum valance to match your hardware color choice.
- The valance attaches to the head rail using a durable plastic clip system.

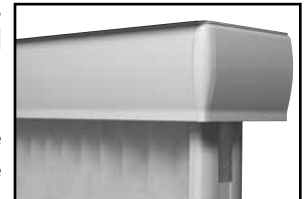

Ovation Valance Dimensions

All valance dimensions are measured on the flat, back side.

- Valance Height: 3¼"
- Standard Return Length (OB only): 3⅞"
- For each spacer block, ½" will be added to the length of the valance returns. For extension brackets, 2" will be added unless otherwise instructed.
- If the slider requires a non-flush inside mount, you must order a custom valance. Exact valance width and exact valance return length (minimum 1½") must be specified in the Special Instructions section of the order form.
- Custom returns are available for IB non-flush and OB Cellular Sliders. Please specify return length upon ordering.

Things to Consider

- Since most Ovations are sold in large sizes, the shade will have a large fabric stack. On an outside mount, you may want to order the shade a few inches wider so that the fabric stack can be clear of the window.
- **Minimum Ovation Stack:** Ovation's minimum fabric stack measures 6½" regardless of the ordered width. Minimum fabric stacking dimensions are determined by the slider's hardware, not ordered width.

The Ultimate Blackout Color Lux® Cellular Shade

INSULATING SLUMBERSHADES HARDWARE SYSTEM

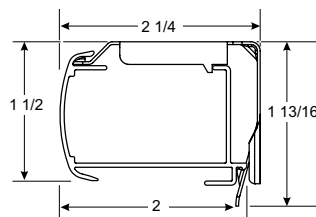
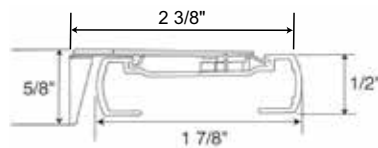

Deluxe Cord Lock Rail

- Depth of rail: 1 7/8"
- Depth of rail and bracket: 2 3/8"
- Height: 1/2"
- Height of bracket: 5/8"

Cord Loop & Cordless Ultra Rail

- Depth of rail: 2"
- Depth of rail and bracket: 2 1/4"
- Height of rail: 1 1/2"
- Height of bracket: 1 13/16"

Hardware Features	
Hardware colors for all Cellular fabrics	Fabric wrapped head, middle, bottom rails and end caps is standard. Back of rail is white to outside.
Blackout Sidetrack Colors Available	White, Tan and Bronze
Upgrades	
Designer Metallic Upgrade	• Oil Rubbed Bronze head, middle, bottom rails and end caps.
Mounting Dimensions (inside mount only) Deluxe Head Rail	
Standard Cord Lock (Standard Rectangular and Top Down-Bottom Up)	
Minimum Inside Mount	1 1/2"
Minimum Flush Inside Mount	2 3/8"
Cord Loop & Cordless Ultra (Standard Rectangular and Top Down-Bottom Up)	
Minimum Inside Mount	1 1/2"
Minimum Flush Inside Mount	2 3/8"
Outside, shallow and side mounts are not available. The shade's light blocking ability is compromised by using any other mount than a fully flush mount application.	
Finished Dimensions	
Inside Mount	
	<ul style="list-style-type: none"> • Fabric will measure ordered width less: 7/8" • Head rail and bottom rail will measure ordered width less: 1 1/16" • Sidetrack length will measure ordered length less: 1/8"

The widest width of the window cannot exceed the narrowest width of the window by more than 1/4".

Precise width measurements are critical to proper performance of SlumberShade products. Make sure to measure to the nearest 1/16" and provide the NARROWEST width measurement along the length of the window. Be sure to measure the top, middle and bottom of the opening. It is very common for the width of a window to vary from top to bottom.

The Ultimate Blackout Color Lux® Cellular Shade

INSULATING SLUMBERSHADES HARDWARE SYSTEM

Applications

- Standard Rectangular • Top Down - Bottom Up
- Cordless and Cordless Top Down - Bottom Up
- Cord Loop and Top Down - Bottom Up
- Motorization

SlumberShades are for inside mount applications only.

Insulating SlumberShade Fabric

Light Filtering fabrics are available as SlumberShades, however the best light control is achieved by using a blackout cellular fabric. Not available in Boutique fabric.

Ordering Information for Insulating SlumberShades

SlumberShades are for inside mount applications only.

Precise width measurements are critical to proper performance of SlumberShade products. Make sure to measure to the nearest $\frac{1}{16}$ " and provide the NARROWEST width measurement along the length of the window. Be sure to measure the top, middle and bottom of the opening. It is very common for the width of a window to vary from top to bottom. The widest width of the window cannot exceed the narrowest width of the window by more than $\frac{1}{4}$ ".

If you have questions about ordering SlumberShades, contact Comfortex Technical Services at 800-843-4151.

Accessories

- 3' Expandable Pole - Silver: (See page 26)
- 5-10' Expandable Pole - Black:

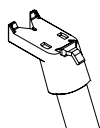

Specially designed pole end fits into the handle on the Cordless Ultra bottom rail and allows for easy operation.

Note: Pole operation with Slumbertrack can cause the rail to tilt and can make smooth operation difficult.

Insulating SlumberShades Features

Use SlumberShades to provide the darkest sleeping environment by sealing out the highest percentage of light.

Energy Saving Blackout Sidetracks

Energy saving blackout sidetracks are made from a durable window grade PVC. The blackout sidetracks seal off the light gap between the blackout cellular shade and the window. The blackout sidetracks feature a black interior lining to absorb light and prevent it from entering the room.



On Top Down - Bottom Up Shades, an extra two-cell fabric gasket attached to the top head rail and acts as a seal to eliminate light leakage between the head rail and middle rail when the shade is closed.

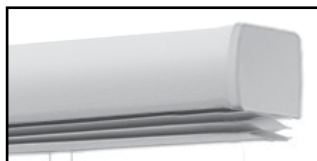

Insulating SlumberShades Large Track Dimensions

Used with all fabrics that utilize the deluxe sized head rail.

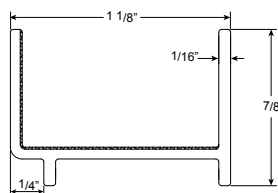

Large Track

- Width of track: $1 \frac{1}{8}$ "
- Height of track: $\frac{7}{8}$ "

SlumberShades are easy to install, and feature removable sidetracks that are attached to the window frame with magnets. The sidetracks can be removed for window cleaning. The UV stable, window grade PVC sidetracks are available in white, tan and bronze to match your existing trim.

Please Note: When properly installed, SlumberShades block 99% of all visible light. In certain installations with intense sunlight, a very small amount of light may reflect around the edges of the honeycomb fabric along each side of the shade. This is a normal attribute of the SlumberShade system.

Insulating SlumberShade End Caps

The specially designed notched bottom rail end caps fit over the blackout sidetracks and allow for smooth movement when raising and lowering the shade.

Head and Bottom Rail Seals

To ensure a perfectly dark sleeping environment, additional fuzz bar are supplied to be placed along the shade's bottom rail and between the head rail and the window frame if needed. These barriers provide a complete light stop all the way around the window to keep all exterior light out. Also, these additional seals provide a very effective barrier against heat loss along your windows.

Magnets and fuzz bar are standard on Cordless and Cordless Top Down-Bottom Up Shades to ensure closure between the bottom rail and window sill.

Energy Efficiency

Independent testing has shown SlumberShades provide an R-value greater than 7.0* when installed over a double paned vinyl window. The testing also indicates that the R-value of a SlumberShade is 2.5 to 3 times higher than that of the same shade without sidetracks. The insulating cellular fabric, sidetracks, and fuzz bar all ensure that the SlumberShades provides superior energy efficiency.

* Independent testing provided by Consortium for Advanced Residential Buildings (CARB), a U.S. Department of Energy Building America research team. Learn more at comfortex.com.

EZ Level

Learn about the EZ Level feature on page 72.

Color Lux® Cellular Shades STRATAVIEW™ HARDWARE SYSTEM

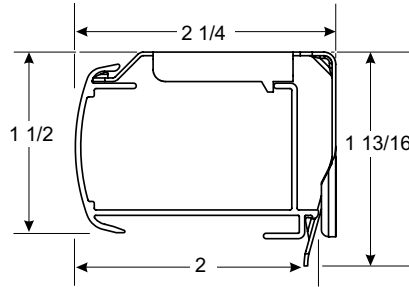

Cord Loop, Cordless Ultra & Simplicity Rechargeable Rail Dimensions

- Depth of rail: 2"
- Depth of rail and bracket: 2 1/4"
- Height of rail: 1 1/2"
- Height of bracket: 1 13/16"

Your choice of Color Lux fabrics as the top and bottom panels.
Aspen fabric not available with Strataview.

Hardware Features

Fabric Wrapped	Fabric wrapped head rail to match color of top fabric/sheer or bottom fabric, middle and bottom fabric wrapped rails will match bottom fabric selection. Back of rail is white to outside. Frosted clear with fabric insert end caps. Clutch cover and Cordloop is white on cordloop shades.
Designer Metallic	<ul style="list-style-type: none"> • Oil Rubbed Bronze head and bottom rails with bronze end caps and white cord.

Mounting Dimensions

Hardware System - Cord Loop , Cordless Ultra & Simplicity Rechargeable

Minimum Shallow Mount	1/2"
Minimum Flush Inside Mount	2 1/4"
Minimum Outside Mount	7/8"
Minimum Side Mount	1 1/4"
Recommended Side Mounting Method	<ul style="list-style-type: none"> • See figure A, page 26 for recommended mounting method for side mount shades • Width limit for side mount brackets is 48"

Finished Dimensions

Inside Mount

- Fabric will measure ordered width less: 3/8"
- Head rail* will measure ordered width less: 3/16"

Outside Mount

- Fabric will measure ordered width
- Head rail* will measure ordered width plus: 3/16"

Side Mount

- Fabric will measure ordered width less: 7/8"
- Head rail* will measure ordered width less: 1 1/16"

Exact (End Cap to End Cap) Mount

- Fabric will measure ordered width less: 3/16"
- Head rail* will measure ordered width

* Head rail measurements include endcaps. Width and length measurements may vary +/- 1/8"



Top Panel and Bottom Panel



Bottom Panel Raised



Top Panel Lowered

Color Lux® Cellular Shades STRATAVIEW™ HARDWARE SYSTEM

StrataView™

StrataView is a dual panel shade featuring your choice of either a sheer or ColorLux fabric panel and Color Lux fabric as the second panel.

Hardware Options

- Cord Loop
- Cordless Ultra
- TDBU Simplicity Rechargeable Motorization
- Friction Fit - [See page 46 for details](#)

Cord Loop Hardware System

See page 27 for details.

Cordless Ultra Hardware System

See page 29 for details.

Simplicity Rechargeable Motorized Hardware System

See page 36 for details.

Recommended Mounting Method for Side Mounting Shades

See Page 26.

EZ Level on Cellular Shades

EZ Level makes quick work of leveling without cords to cut or tuck into a rail. Middle rail can also be adjusted in the field. See page 72 for details.

StrataView Fabric Specifications

Sheer fabric is available on the top of the shade.

See fabric samples of the 4 sheer fabrics for the top of the StrataView in the Color Lux Sample Book.

BOTTOM FABRICS

CELLULAR	Width		Length	
	Min	Max	Min	Max
Cordless	18" OB 18¾" IB	96"	8"	84"
Cordloop	22"	108"	8"	120"
Motorized	24" OB 24¾" IB	108"	8"	120"

Motorized StrataView Shades less than 36" in width require an external mounted battery.

MOTORIZED STRATAVIEW TOP DOWN-BOTTOM UP PRICING EXAMPLE:

Linen Weave	
Light Filtering 42" x 60" Shade:	\$611.00
Simplicity Rechargeable Surcharge:	\$515.00
Charger for Rechargeable:	\$30.00
TDBU Remote Control:	\$50.00
Total List Price:	\$1206.00

Ordering Information for StrataView Shades

Cord Loop StrataView

- Specify IB or OB mount and rail color.
- Middle and bottom rail will match the bottom fabric. Top rail can match top or bottom fabric, your choice.
- Specify cord loop length when ordering.
- Controls are the right cord loop operates the middle rail and left cord loop operates the bottom. Reverse controls are not available.

Cordless Ultra StrataView

- Specify IB or OB mount and rail color.
- Middle and bottom rail will match the bottom fabric. Top rail can match top or bottom fabric, your choice.

Accessories

- 3' Expandable Pole - Silver: (see page 26)
- 5-10' Expandable Pole - Black:



Specially designed pole end fits into the handle on the Cordless Ultra bottom rails and allows for easy operation.

Simplicity Rechargeable StrataView

- Specify IB or OB mount and rail color.
- Middle and bottom rail will match the bottom fabric. Top rail can match top or bottom fabric, your choice.
- Specify remote and other accessories if needed.
- Specify one or more battery chargers.

StrataView Simplicity Motor Hand Held Remote 14 Channel Remote

The TDBU remote has 14-channels. Each channel has a setting to operate the middle rail and a setting to operate the bottom rail. The TDBU remote is required for StrataView motors. The **14 Channel TDBU remote** can operate up to fourteen shades individually or 14 groups. Simplicity Rechargeable Motorized Cellular Shades are programmed at the factory with the "up and down" limits. The shades are **UNLINKED** from the remote so they are not able to operate during shipping. Each shade should be installed **after** linking it to the remote.



Simplicity TDBU remotes and holders are white in color. The remote comes with a holder which can be mounted to a wall for easy storage. The range of the remote is approximately 80 feet.

REMEMBER: Order at least one charger if ordering rechargeable motor

Recommended Mounting Method for Side Mounting Shades [See Page 26.](#)

NEW Simplicity Bluetooth Motorization

Learn about Simplicity Bluetooth motorization and Comfortex FREE Color Lux Mobile App on [page 33.](#)

Color Lux® Cellular Specialty Shades

STARBURST ARCHES HARDWARE SYSTEM

Stationary Starburst

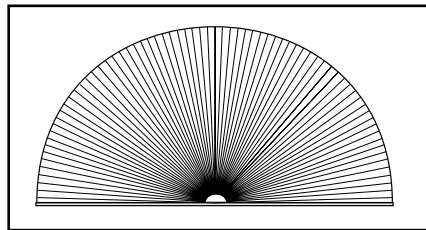

Figure A

Movable Starburst

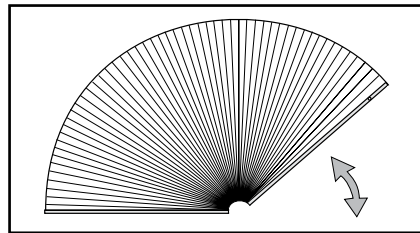

Figure B

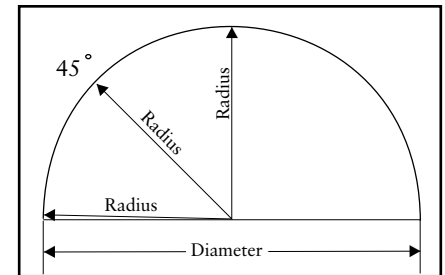

Figure C

Hardware Features | See Page 25 for Rail Dimensions

Standard Hardware	Fabric wrapped rail is standard. The fabric will be spliced in the center of the rail. A decorative rosette is supplied to conceal the splice.
Designer Metallic	<ul style="list-style-type: none"> Oil Rubbed Bronze rails with bronze colored end caps.

Mounting Dimensions

Mounting Dimensions	Standard Cord Lock Rail
Minimum Shallow Mount	3/4"
Minimum Flush Inside Mount	2 3/8"
Recommended Side Mounting Method	<ul style="list-style-type: none"> See figure B, pg 26 for recommended mounting method for side mount shades Width limit for side mount brackets is 48"

Finished Dimensions

Inside and Side Mount

<ul style="list-style-type: none"> Fabric will measure ordered width less: 3/8" Head rail* will measure ordered width less: 3/16" 	<ul style="list-style-type: none"> * Head rail measurements include endcaps. Width and length measurements may vary +/- 1/8"
---	--

Applications

- Stationary Fan Style Arch
 - Movable Fan Style Arch
- Movable Starburst Arch shades are for inside and shallow mount applications only.

Stationary Starburst Features (Figure A)

- All non-perfect Stationary Starburst arches require a template made from brown craft paper.** Comfortex offers template kits. Please contact Customer Service to order. Stock number: 751000, See page 75
- A perfect arch is twice as wide as it is high.
- Stationary Starburst shades which are not perfect half circles must have a height that equals half the width +/- 5".
- Price according to the largest radius measurement. If the height is greater than the width, take height X 2 and use that number to determine pricing.
- When ordering arches as perfect half-circles make sure the radius of the arch remains constant to ensure a proper fit. (See Figure C)

Movable Starburst Features (Figure B)

- Starburst Movable archtop shades are cut to perfect half circles only and do not require a template. The height must be exactly 1/2 the diameter.
- A perfect arch is twice as wide as it is high.
- When ordering arches as perfect half circles make sure the radius of the arch remains constant to ensure a proper fit. (See Figure C)
- The hinge gap (gap between the two rails) is not centered in the window. The moving rail is always smaller than the stationary rail to provide proper movement within the window.

Accessories

- 5-10' Expandable Pole - Black:



Specially designed pole end fits into the handle on movable Starburst Shades for easy operation.

Color Lux® Cellular Specialty Shades

QUARTER ROUNDS HARDWARE SYSTEM

Movable Quarter Round

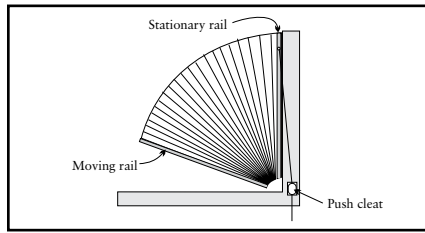

Figure A

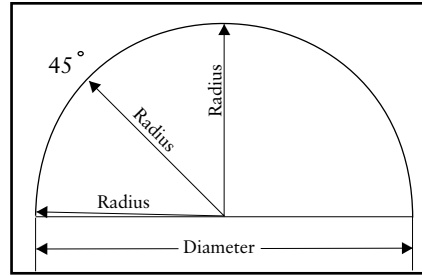

Figure B

Stationary Quarter Round

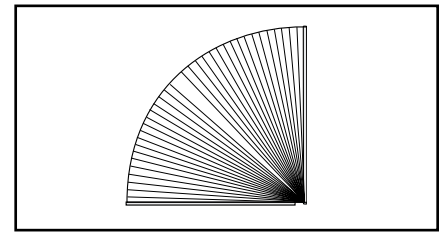

Figure C

Hardware Features | See Page 25 for Rail Dimensions

Hardware colors for all Cellular and Pleated fabrics | Fabric wrapped rails with white cord and tassel. Fabric used is same fabric as the shade. Back of rail is white to outside.

Upgrades

Designer Metallic Upgrade • Oil Rubbed Bronze rails and endcaps, bronze colored tassel and white cord.

Mounting Dimensions	Standard Rail	Deluxe Rail
Minimum Shallow Mount	3/4"	3/4"
Minimum Flush Inside Mount	2"	2 3/8"
Minimum Outside Mount	3/4"	3/4"
Minimum Side Mount	1 1/8"	1 3/8"
Recommended Side Mounting Method	• See page 26 figure B for recommended mounting method for side mount shades	

Finished Dimensions

Inside and Side Mount
• Fabric will measure ordered width less: 3/8" • Head rail* will measure ordered width less: 3/16"
Outside Mount
• Fabric will measure ordered width • Head rail* will measure ordered width plus: 3/16"
Exact (End Cap to End Cap) Mount
• Fabric will measure ordered width less: 3/16" • Head rail* will measure ordered width

* Head rail measurements include endcaps.
 Width and length measurements may vary +/- 1/8"

Applications

- Stationary Fan Style Quarter Round
- Movable Fan Style Quarter Round

Ordering Information for Quarter Rounds Shades

- Specify IB or OB mount and rail color.
- Include a template if the shade is a non-perfect quarter round.

Accessories

- 5-10' Expandable Pole - Black:



Specially designed pole end fits into the handle on movable Quarter Round Shades for easy operation.

Color Lux® Cellular Specialty Shades QUARTER ROUNDS HARDWARE SYSTEM

Quarter Rounds Features (Figure B, page 54)

- **All Quarter Round Shades which are not perfect quarter circles require a template.** Price according to the largest radius measurement.
- See page 75 for template instructions.
- **All templates should be made from brown craft paper.** Comfortex offers template kits. Please contact Customer Service to order. Stock number: 751000
- The horizontal (moving) rail of a Movable Quarter Round shade **must be smaller** than the vertical (stationary) rail to allow clearance for the moving rail. The shade will stack in the vertical position.
- When ordering arches as perfect quarter circles, make sure the radius of the arch remains constant to ensure a proper fit. (See Figure B, page 54)



Color Lux® Cellular Specialty Shades

SUNSET ARCHES HARDWARE SYSTEM

Movable Sunset

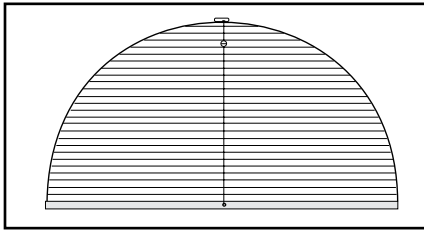

Figure A

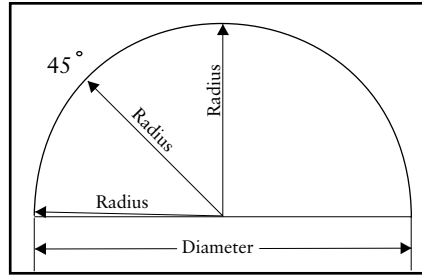

Figure B

Two-String Hanging Method

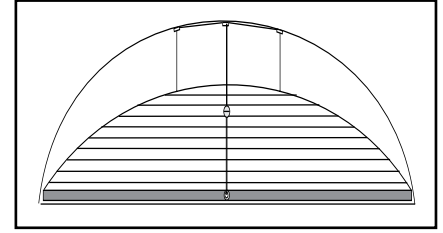

Figure C

Hardware Features | See Page 25 for Rail Dimensions

Fabric Wrapped	Fabric used is same fabric as the shade. Back of rail is white to outside. Clear frosted end caps, white cord and silver tassel
Designer Metallic	<ul style="list-style-type: none"> Oil Rubbed Bronze rails with bronze colored end caps and white cord.

Mounting Dimensions	Standard Cord Lock Rail
Minimum Shallow Mount	3/4"
Minimum Flush Inside Mount	2 3/8"
Minimum Outside Mount	3/4" Outside mounting requires the use of an extension "L" bracket for the mounting of the top block.
Minimum Side Mount	1 1/8"
Recommended Side Mounting Method	<ul style="list-style-type: none"> See page 57, figure F for recommended mounting method for side mount shades Width limit for side mount brackets is 48"

Finished Dimensions

Inside and Side Mount	
	<ul style="list-style-type: none"> Fabric will measure ordered width less: 3/8" Head rail* will measure ordered width less: 3/16"
Outside Mount	
	<ul style="list-style-type: none"> Fabric will measure ordered width Head rail* will measure ordered width plus: 3/16"
Exact (End Cap to End Cap) Mount	
	<ul style="list-style-type: none"> Fabric will measure ordered width less: 3/16" Head rail* will measure ordered width

* Head rail measurements include endcaps.
 Width and length measurements may vary +/- 1/8"

Applications

- Movable Arch

Ordering Information for Sunset Shades

- Specify IB or OB mount and rail color.
- Include a template if the shade is a non-perfect arch.

Accessories

- 3' Expandable Pole - Silver: (see page 26)
- 5-10' Expandable Pole - Black



Specially designed pole end fits into the ball on Sunset Shades for easy operation.

Color Lux® Cellular Specialty Shades SUNSET ARCHES HARDWARE SYSTEM

Sunset Features and Ordering Notes

(Figure A, pg 56)

- Sunset shades have horizontal pleats that stack at the bottom, on a stationary sill rail. Sunset shades are operated by a continuous cord that runs through a top mount guide block and back down through the stationary rail. A moving metal ball attached to the cord is used to raise and lower the shade. (See Figure E).
- **All Sunset arches which are not perfect half circles require a template.** A perfect arch is twice as wide as it is high. See page 75 for template instructions.
- **All templates should be made from brown craft paper.** Comfortex offers template kits. Please contact Customer Service to order. Stock number: 751000
- Sunset shades which are not perfect half circles must have a height which is equal to or greater than 25% of the width.
- When ordering Sunset shades that are perfect half circles, make sure the radius of the arch remains constant to ensure a proper fit. (See Figure B).
- **Stringing Method:** Depending on the curvature of a particular arch, it may be necessary to use the two string method (See Figure C) to ensure proper fit and operation of your Sunset shade. Comfortex will determine the best stringing method after examination of the template.
- **Arch Styles:** Sunset arches are available in a variety of styles including: palladium, eyebrow and bullet shaped arches. (See Figure D).

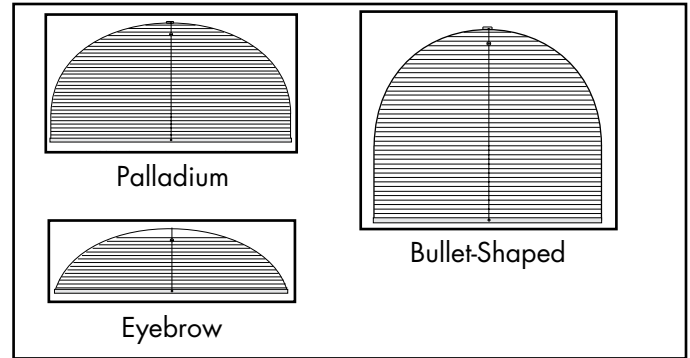

Figure D

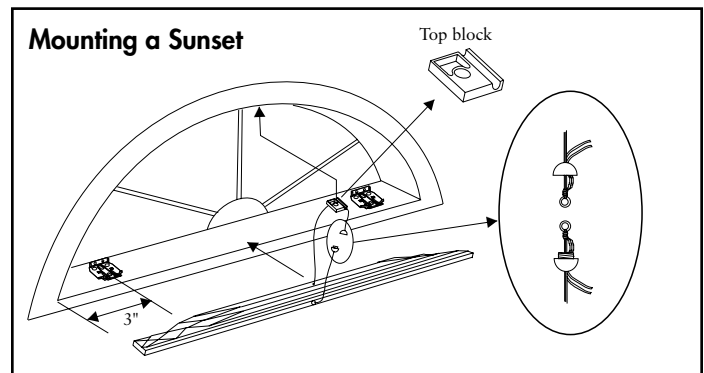

Figure E

Recommended Mounting Method for Side Mounting Shades

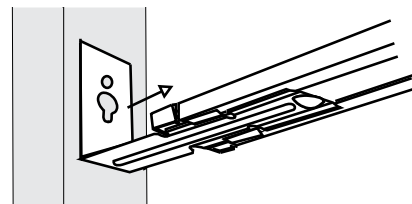

Figure F

Refer to the installation instructions on Comfortex.com or the OnDemand Mobile Library for further details on side mounting shades.

Color Lux® Cellular Specialty Shades

TRAPEZOIDS AND OCTAGONS HARDWARE SYSTEM

Movable Trapezoids

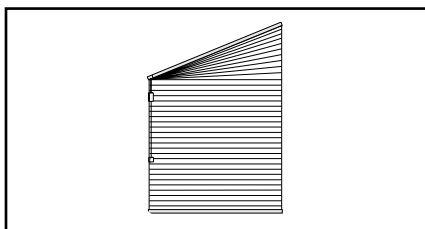

Movable Octagons

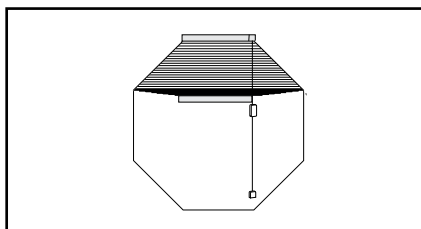

Hardware Features | See Page 25 for Rail Dimensions

Fabric Wrapped	Fabric used is same fabric as the shade. Back of rail is white to outside. Frosted clear end caps with white cord and tassel
Designer Metallic	<ul style="list-style-type: none"> Oil Rubbed Bronze head and bottom rails with bronze colored tassel, end caps and white cord.

Mounting Dimensions

Standard Cord Lock Rail

Minimum Shallow Mount	3/4"
Minimum Flush Inside Mount	2"
Minimum Outside Mount	3/4"
Minimum Side Mount	1 1/8"
Recommended Side Mounting Method	<ul style="list-style-type: none"> See page 57 for recommended mounting method for side mount shades Width limit for side mount brackets is 48"

Finished Dimensions

Inside and Side Mount

- Fabric will measure ordered width less: 3/8"
- Head rail* will measure ordered width less: 3/16"

Outside Mount

- Fabric will measure ordered width
- Head rail* will measure ordered width plus: 3/16"

Exact (End Cap to End Cap) Mount

- Fabric will measure ordered width less: 3/16"
- Head rail* will measure ordered width

* Head rail measurements include endcaps.
 Width and length measurements may vary +/- 1/8"

Applications

- Movable Trapezoids
- Movable Octagons

Ordering Information for Octagon Shades

- Specify IB or OB mount and rail color.
- The width, length and one side are required measurements when ordering.**

Ordering Information for Trapezoid Shades

- Specify IB or OB mount and rail color.
- Trapezoid orders must be faxed or emailed in with a diagram. Please provide measurements for all four sides when ordering. No template is required.**

Color Lux® Cellular Specialty Shades

TRAPEZOIDS AND OCTAGONS HARDWARE SYSTEM

Trapezoids (Figure A)

- Trapezoid orders must be faxed in with a diagram. Please provide measurements for all four sides when ordering. No template is required.
- The maximum slope of the top rail is 30 degrees from horizontal. Slope is the angle between slope and a horizontal line. The slope angle must be measured with a protractor.
- Sides of trapezoid must be parallel.
- Sill must be level for proper installation and operation of a trapezoid shade.
- Operating cord must be placed on the short side.
- See Figures B and C for trapezoid shade operation.
- Max top rail width = 48"

Octagons

- The width, length and one side are required measurements when ordering.
- Octagon shades raise only to the point where the top angle begins. (See Figure D)
- See Figure F on page 57 for recommend mounting method for side shades.
- Width limit for side mount brackets is 48".

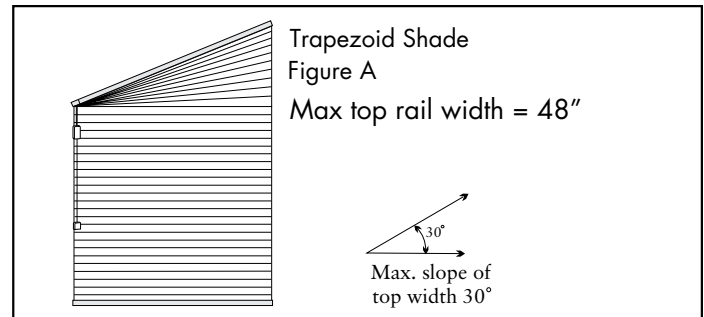

Trapezoid Shade Operation

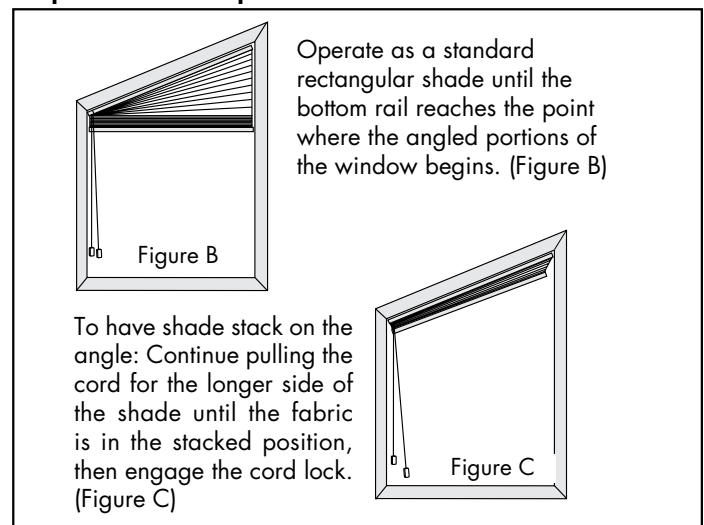

Octagon Operation

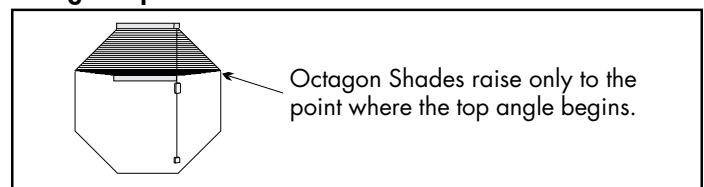
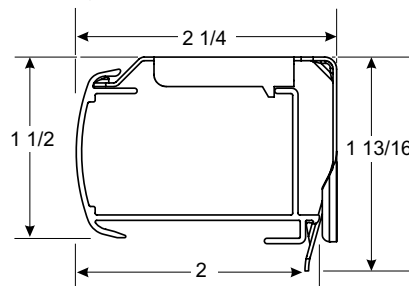

Figure D

Color Lux® Cellular Specialty Shades

MEZZO MOTORIZED SKYLIGHT HARDWARE SYSTEM

WITH QUIETUDE™ TECHNOLOGY



Simplicity Motorized Rail Dimensions

- Depth of rail: 2"
- Depth of rail and bracket: 2 1/4"
- Height of rail: 1 13/16"
- Height of bracket: 1 1/2"

Mezzo Motorized Skylight Shades are designed for fabric to stack from the top only.

Hardware Features

Hardware colors	White head, bottom and side rails
Simplicity Remotes	Upper and lower limit stops pre-programmed, Intermediate stop "favorites" position can be set on site, 5 channel, 6 channel timer or 14 channel option

Mounting Dimensions

Mounting Dimensions	Mezzo Motorized Skylight Shades
Minimum Flush Inside Mount	2 1/2"
	<ul style="list-style-type: none"> • Should not be more than 1/2" out of square to perform as intended • The widest width of the window cannot exceed the narrowest width of the window by more than 3/8". • The shade must be mounted with the fabric stack at the top of the window
	See page 37 for Solar Panel information.

Finished Dimensions

Inside Mount

	<ul style="list-style-type: none"> • Fabric will measure ordered width less: 1 1/4" • Head rail* will measure ordered width less: 3/16"
--	---

* Head rail measurements include endcaps. Width and length measurements may vary +/- 1/8"

MOTORIZATION - HARDWARE UPGRADE SURCHARGES AND ACCESSORIES | All standard discounts apply to motorized shades

	ADD
Simplicity - Motor and Rechargeable Battery Pack	\$300
Simplicity 14 Channel White Remote	\$50
48" Extension Wire:	\$10
Simplicity Smart Controller (NEO)	\$280
NEO App for Mobile Devices	FREE on App Store
Color Lux Mobile BlueTooth App	FREE on App Store
Solar Panel with brackets	\$120
Plug In Charger: for rechargeable battery pack	\$30

Ordering Information for Mezzo Motorized Skylight Shades

- Specify inside mount dimensions.
- Specify fabric color and style.
- Specify remote and other accessories if needed.

Ultra Feature:

Ultra - is a synthetic lift cord that allows cordless Color Lux cellular shades to more easily move up and down.

[More information on page 29.](#)

Color Lux® Cellular Specialty Shades

MEZZO MOTORIZED SKYLIGHT HARDWARE SYSTEM

WITH QUIETUDE™ TECHNOLOGY



Applications

- Angled and Vertical motorized skylight shades.
- Mezzo Motorized Skylight Shades are for inside mount applications only.
- **Skylights with Simplicity motorization will not operate properly if installed in a completely horizontal application. The minimum recommended slope is 5 degrees.**
- Must be mounted with fabric stack at the top.

Mezzo Power Options

- Simplicity Rechargeable Motor

Front Access Control

All Color Lux Cellular Shades with Rechargeable Simplicity motors come with a front-facing, flip-top cover for convenient access to the charging port, reset button, and on/off switch.

Shades with front control access include an auxiliary charging port in the back. This port is ideal for a solar panel charging kit.

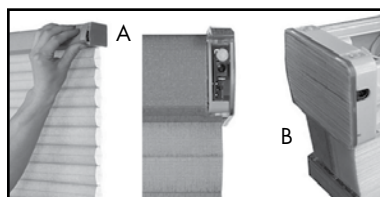

A) Front Control
B) Back of Head rail.

Simplicity Rechargeable Battery

The rechargeable battery is concealed in the head rail of the shade. A charger is required for the rechargeable battery. The rechargeable battery comes fully charged from the factory.

Simplicity Hand Held Remote

14 Channel Remote

The TDBU remote has 14-channels. This remote is required for TDBU motorization but can be utilized on all Simplicity motorized shades. Each channel has a setting to operate the middle rail and a setting to operate the bottom rail. The TDBU remote is required for TDBU motors. The **14 Channel TDBU remote** can operate up to fourteen shades individually or 14 groups. Simplicity Rechargeable Motorized Cellular Shades are programmed at the factory with the "up and down" limits. The shades are **UNLINKED** from the remote so they are not able to operate during shipping. Each shade should be installed **after** linking it to the remote.



Simplicity TDBU remotes and holders are white or black in color. The remote comes with a holder which can be mounted to a wall for easy storage. The range of the remote is approximately 80 feet.

Battery Charger

8.4 Volt charger requires a standard power outlet to recharge the battery. You must specify charger when ordering a Simplicity Rechargeable shade. The charger plugs into the charger port. The charger is black and comes with a 156" (13') wire. The dimensions are 1" wide x 2½" length x 1¾" deep.



Important Simplicity Motorized Shades Operating and Installation Information

- Simplicity Motorized Shades installed into windows with metal casings may have a reduced radio frequency range, or may not operate at all, depending on the application.
- Do not let the antenna on the motor touch any metal objects. This may interfere with signals from the remote control.
- Make sure to leave the top of the shade head rail open (motor exposed), do not cover; especially with metal materials. This could result in a reduced radio frequency range for the remote control or the shade may not operate at all, depending on the application.

Life of charge is subject to application variables such as, size and weight of shade, frequency of use, amount of direct sunlight exposure, etc.



Dimensions of panel
18½" x 1½"

Please Note:

LED solar panel cord length is 24". Make sure to order 48" extension cord if needed.

Solar Recharge Optimum Application

- Full direct sunlight (minimum 2 hours per day) to maintain full charge. Based on one operation cycle per day (one open, one close).
- Excessive duration of cloudy weather will impact the rate of charge.

Color Lux® Cellular Specialty Shades

MEZZO MOTORIZED SKYLIGHT HARDWARE SYSTEM

WITH QUIETUDE™ TECHNOLOGY



Solar Panel LED Lights

Red Light: Indicates optimum direct sun exposure

Green Light: Indicates sunlight is enough to charge battery

Blue Light: Indicates battery is charging. Blue light is off when not charging (including when the battery is full)

No Lights: Night or very low sun



Red Light

Green Light

Blue Light

No Light



Solar Panel Mounting

Bottom portion of the bracket may be lowered if needed for more sun exposure. Bracket can be mounted behind or next to shade mounting bracket.

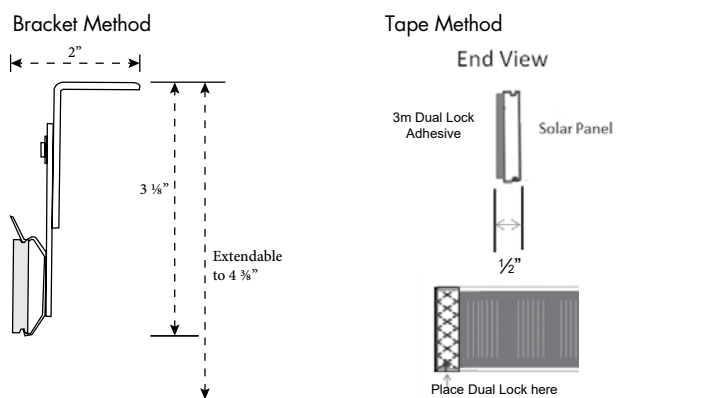

Tape goes on the face (black side) of the panel.

If the solar panel is mounted directly behind the headrail at the top of the window, you need to make sure that the solar panel does not interfere with the shade mounting brackets. The solar panel can go between brackets spaced apart, or behind brackets if the depth of the window casing allows.



Cellular Specialty Shades

SOPRANO SKYLIGHT & GREENHOUSE HARDWARE SYSTEM

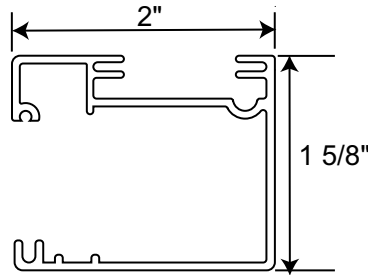

Soprano Rail Dimensions

- Depth of rail: 2"
- Height of rail: 1 5/8"

Hardware Features		
Hardware colors	<ul style="list-style-type: none"> • White head, bottom rail with white gear track retainer. • Bronze head, bottom rail with bronze gear track retainer. 	
Mounting Dimensions	Soprano Skylights Shades	
Minimum depth required for installation	1 1/2"	
Minimum Flush Inside Mount (Rail Fully Recessed)	2 3/8"	
Minimum Flush Inside Mount (Handle Fully Recessed)	3"	
Deductions		
	Total deduction on the bottom moving rail is 3 1/4"	
	Total deduction on the top rail is 1 1/2"	
Finished Dimensions	Aspen	All Other Fabrics
Inside Mount	<ul style="list-style-type: none"> • Fabric will measure ordered width less: 3/8" • Head rail* will measure ordered width less: 3/16" 	
	less 1 1/2"	less 1 5/16"
* Head rail measurements include endcaps. Width and length measurements may vary +/- 1/8"		

Applications

- Soprano Skylights
- Soprano Shades are for inside mount applications only.

Ordering Information for Soprano Skylights Shades

- Specify White or Bronze Rails.

Accessories

- Two Moving Rails*
- 5-10' Expandable Pole - Black

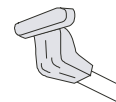

Specially designed pole end fits into the handle of Soprano shades for easy operation at any angle.

*This option allows you to move shade up from the bottom or down from the top. For ultimate control of light and privacy. See page 9 for upgrade pricing.

Skylight Installation Angles

- For inside mount applications on straight (planar) runs.
- Minimum Installation angle of 5 degrees.
- Maximum installation angle of 85 degrees.
- Horizontal (0 degrees) and vertical (90 degrees) applications are not recommended.

Cellular Specialty Shades

SOPRANO SKYLIGHTS AND GREENHOUSE SHADES HARDWARE SYSTEM

Soprano Skylight Features (Figure A)

- Soprano Shades feature a polycarbonate track system. The hidden gear track allows for smooth operation of the shade and controls light.
- The gear track retainer is White or Bronze to match the moving bottom rail. **Please specify rail color when ordering.**

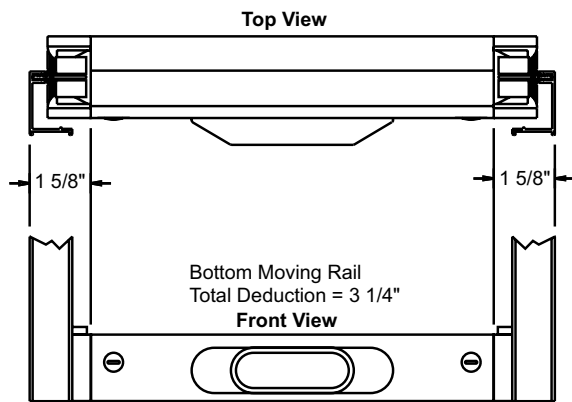

Soprano Skylights Moving Rail
Top and Front View

Soprano Skylights

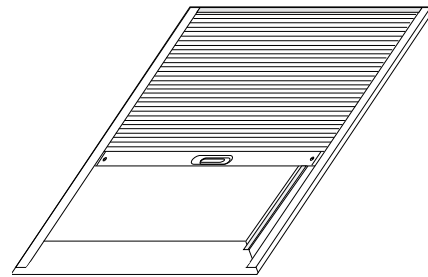
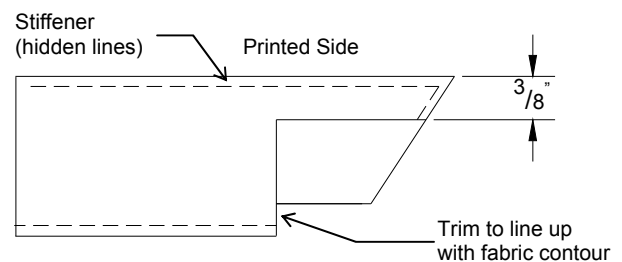

Figure A

Soprano Fabric Notch

(Aspen Only - other fabrics slotted. See below)



Additional trimming for bottom stiffener
(and attached single layer of fabric).

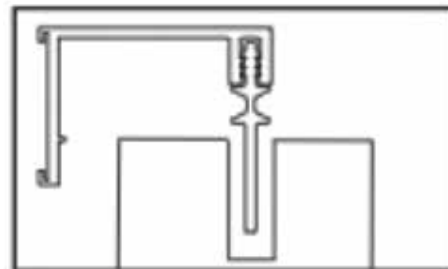

Cellular Specialty Shades

BALCONY SHADING HARDWARE SYSTEM

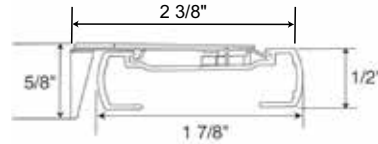
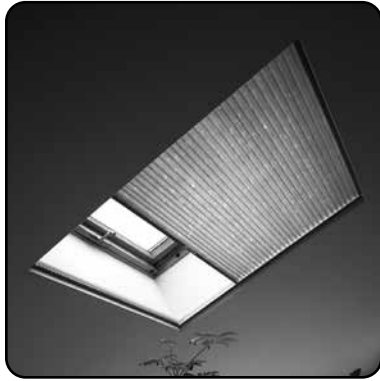

Balcony Shading Rail

- Depth of rail: 1 7/8"
- Depth of rail and bracket: 2 3/8"
- Height: 1/2"
- Height of bracket: 5/8"

Hardware Features	
Hardware colors for all fabrics	Fabric wrapped head and bottom rails with white cord in a white sidetrack.
Upgrades	
Designer Metallic Upgrade	• Designer Oil Rubbed Bronze head and bottom rails with white cord in a white sidetrack.
Mounting Dimensions - Inside Only	
Balcony Shading System	
Minimum required for installation	2 1/4"
Minimum Flush Inside Mount (Rail Fully Recessed)	3 1/4"
Minimum Flush Inside Mount (Handle Fully Recessed)	3 11/16"
The widest width of the window cannot exceed the narrowest width of the window by more than 3/8".	
Finished Dimensions	
Inside Mount	
	<ul style="list-style-type: none"> • Fabric will measure ordered width less: 1" • Head rail* will measure ordered width less: 3/16"
* Head rail measurements include endcaps. Width and length measurements may vary +/- 1/8"	

Applications

- Horizontal*, Angled and Vertical rectangular windows and skylights. Balcony Shading Systems are for inside mount applications only.

Accessories

- 3' Expandable Pole - Silver: (see page 26)
- 5-10' Expandable Pole - Black



Specially designed pole end fits into the handle of Balcony shades for easy operation at any angle.

Ordering Information for Balcony Shading System

- Specify rail color.
- Specify when ordering: Application angle: Angled, Horizontal or Vertical.

Cellular Specialty Shades

BALCONY SHADING HARDWARE SYSTEM

Balcony Shading System Features

- Balcony Shades work in three orientations applications: Angled, Horizontal and Vertical.
Horizontal works on slope angles 5 to 15 degrees.
Angled works on slope angles 15 to 75 degrees.
Vertical works on slope angles 75 to 90 degrees.
- Balcony shades can be mounted on their side. (See Figure A). Use the vertical measurement as your width (max. 36") and the horizontal measurement as your length (max. 48").
- Polycarbonate track system provides superior insulation and light blocking. The enclosed sides provide full privacy.
- No exposed cords, eliminates risk of injury to children.

Balcony Vertical Applications

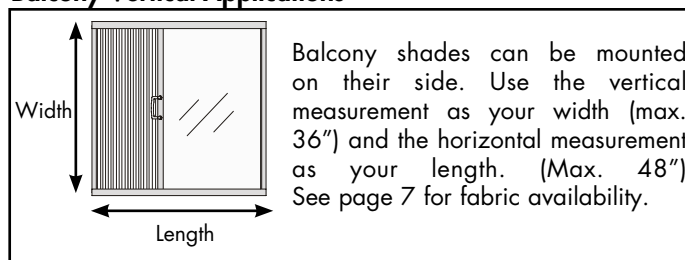

Figure A

Maximum Shade Area

Maximum shade areas (in square feet) varies with slope and fabric type.

	Horizontal	Angled	Vertical
All Fabrics	24	24	18



Color Lux® Cellular Specialty Shades

FRENCH DOOR DÉCOR HARDWARE SYSTEM



Deluxe Head Rail

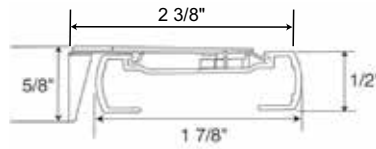

Deluxe Rail

- Depth of rail: 1 7/8"
- Depth of rail and bracket: 2 3/8"
- Height: 1/2"
- Height of bracket: 5/8"

Hardware Features	
Fabric Wrapped Upgrade	Fabric used is same fabric as the shade. Back of rail is white to outside. Frosted clear end caps with fabric insert.
Designer Metallic Upgrade	<ul style="list-style-type: none"> • Oil Rubbed Bronze head, middle, bottom rails and end caps.

Mounting Dimensions	French Door Decor Hardware System
Minimum Shallow Mount	3/4"
Minimum Flush Inside Mount	2 3/8"
Minimum Outside Mount	3/4"
Minimum Side Mount	1 3/8"
Recommended Side Mounting Method	<ul style="list-style-type: none"> • See page 26 for recommended mounting method for side mount shades • Width limit for side mount brackets is 48"

Finished Dimensions	
Inside and Side Mount	
	<ul style="list-style-type: none"> • Fabric will measure ordered width less: 3/8" • Head rail* will measure ordered width less: 3/16"
Outside Mount	
	<ul style="list-style-type: none"> • Fabric will measure ordered width • Head rail* will measure ordered width plus: 3/16"
Exact (End Cap to End Cap) Mount	
	<ul style="list-style-type: none"> • Fabric will measure ordered width less: 3/16" • Head rail* will measure ordered width
<p>* Head rail measurements include endcaps. Width and length measurements may vary +/- 1/8"</p>	

Color Lux® Cellular Specialty Shades

FRENCH DOOR DÉCOR HARDWARE SYSTEM

Applications

- Stationary Door Décor
- Movable Door Décor
- Top Down - Bottom Up Door Décor
- Cover French doors, transoms, and side lights.

French Door Décor Hardware Features

- Features two non-moving rails which are mounted in the window or door. A tension control system enables the movable rail to be easily moved with the touch of a finger. The only visible cords are the ones that hold the movable middle rail in place.
- The widest width of the window cannot exceed the narrowest width of the window by more than $\frac{3}{8}$ ".

Stationary Non-Movable French Door Décor Shades

- Top and bottom rails are mounted to the window and are stationary.

Movable French Door Décor Shades

- Top and bottom rails are mounted to the window, one middle movable rail raises from the bottom.

Top Down - Bottom Up Option

- Top and bottom rails are mounted to the window, two movable rails allow the shade to lower from the top and raise from the bottom.
- The non-movable top and bottom rails are attached to the window or door.
- Ideal for entry ways with narrow windows next to doors and other narrow windows that are easily accessible.

Ordering Information for French Door Décor

- Specify IB or OB mount and rail color.
- Specify stationary, movable or Top Down - Bottom Up.

Accessories

- 5-10' Expandable Pole - Black:

Specially designed pole end allows for easy operation of French Door Décor Shades.

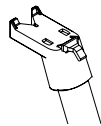

French Door Decor Cellular Shades Hardware

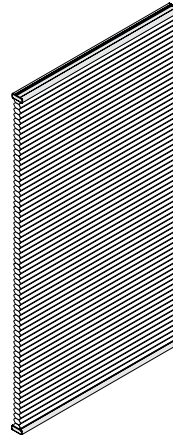

Stationary Non-Movable

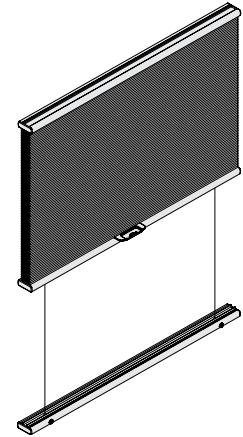

Shown open with movable rail option

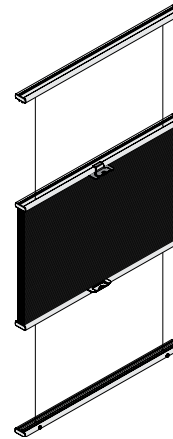

Shown open with Top Down - Bottom Up Option

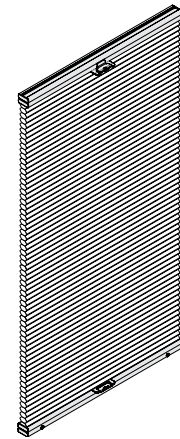

Shown closed with Top Down - Bottom Up Option

Color Lux® Cellular Specialty Shades

DAY-NIGHT SHADES HARDWARE SYSTEM



Deluxe Head Rail

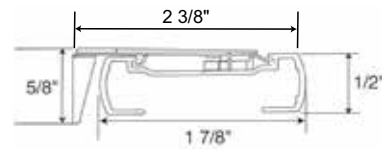

Deluxe Rail

- Depth of rail: 1 7/8"
- Depth of rail and bracket: 2 3/8"
- Height: 1/2"
- Height of bracket: 5/8"

Hardware Features	
Fabric Wrapped Upgrade	Fabric used is same fabric as the shade. Back of rail is white to outside. Frosted clear end caps with fabric insert.
Designer Metallic Upgrade	• Oil Rubbed Bronze head and bottom rails with bronze colored tassel, end caps and white cord.

Mounting Dimensions	Standard Cord Lock Rail
Minimum Shallow Mount	3/4"
Minimum Flush Inside Mount	2 3/8"
Minimum Outside Mount	3/4"
Minimum Side Mount	1 1/8"
Recommended Side Mounting Method	<ul style="list-style-type: none"> • See page 26 for recommended mounting method for side mount shades • Width limit for side mount brackets is 48"

Finished Dimensions	
Inside and Side Mount	
	<ul style="list-style-type: none"> • Fabric will measure ordered width less: 3/8" • Head rail* will measure ordered width less: 3/16"
Outside Mount	
	<ul style="list-style-type: none"> • Fabric will measure ordered width • Head rail* will measure ordered width plus: 3/16"
Exact (End Cap to End Cap) Mount	
	<ul style="list-style-type: none"> • Fabric will measure ordered width less: 3/16" • Head rail* will measure ordered width
* Head rail measurements include endcaps. Width and length measurements may vary +/- 1/8"	

Applications

- Standard Rectangular with cellular fabrics only.

Day - Night Shade Specifications

Refer to the appropriate fabric sections for proper pricing.

Color Lux® Cellular Specialty Shades

DAY-NIGHT SHADES HARDWARE SYSTEM

Rail Colors and Cord Colors

- **Color Coordinated Rail Shades:** The top rail and middle rail will coordinate with top fabric and bottom rail will coordinate with the bottom fabric. The cord and tassel will be white. Not available with Color Lux Shades.
- **Designer Metallic Hardware Shades:** All rails, end caps and tassels will be the selected metallic color. Cords will be white.
- **Fabric Wrapped Rail Shades:** The top rail and middle rail will coordinate with top fabric and bottom rail will coordinate with the bottom fabric. The cord and tassel will be white. End caps and cord lock will be color coordinated.

Hardware Options

- Cord Lock

Ordering Information for Day - Night Shade

- Specify fabrics, top and bottom panels.
- Specify IB or OB mount and rail color.

TOP FABRIC

CELLULAR	Width		Length	
	Min	Max	Min	Max
Verona	12"	72"	18"	96"
Boutique	12"	72"	18"	96"
Baritone (all)*	12"	72"	18"	96"
Debut ½" Double Cell Light Filtering	12"	72"	18"	96"
Debut ¾" Single Cell Light Filtering	12"	72"	18"	96"
Color Lux Linen Weave Light Filtering*	12"	72"	18"	96"
Color Lux Linen Weave Room Darkening*	NA	NA	NA	NA
Linen Weave Light Filtering*	12"	72"	18"	96"
Linen Weave Room Darkening*	NA	NA	NA	NA
Premiere ¾" Single Cell Blackout	NA	NA	NA	NA
Premiere ¾" Single Cell Light Filtering	12"	72"	18"	96"
NEW Aspen	12"	72"	18"	96"

BOTTOM FABRIC

Width		Length	
Min	Max	Min	Max
12"	72"	18"	96"
12"	72"	18"	96"
12"	72"	18"	96"
12"	72"	18"	96"
12"	72"	18"	96"
12"	72"	18"	96"
12"	72"	18"	96"
12"	72"	18"	96"
12"	72"	18"	96"
12"	72"	18"	96"
12"	72"	18"	96"
12"	72"	18"	96"
12"	72"	18"	96"
12"	72"	18"	96"

* Day-Night Shades can only be built in conjunction with other ¾" cellular fabrics. All Debut includes print patterns: Strie, Terazzo, Angel Hair, Strat, Florance, Blossom, Country Woven and Homespun.



EZ Level



Making A Template



Measuring



Child Safety



Cleaning & Care

Color Lux® Cellular Shades

EZ LEVEL

EZ Level makes quick work of leveling without cords to cut or tuck into a rail. No special tools needed – just use a nickel, quarter or penny to adjust plug on the bottom rail.

EZ Level is standard on all Cellular and Pleated Shades with the following hardware systems:

- Standard and Deluxe Cord Lock
- Cordless Ultra
- Cord Loop
- SlumberShades
- Simplicity Motorized Systems

EZ Level is not available with Lift & Lock Cordless.

How does EZ Level work?

- Slightly raise the bottom rail you want to level.
- Insert a coin or flat head screwdriver into the adjustment screw and turn it.
- Turn the adjustment screw clockwise or counter clockwise to make slight adjustments up or down. One quarter turn of the adjustment screw will move the bottom rail up or down $\frac{1}{4}$ ".
- Lower the rail to check the level and make further adjustments if necessary.



Cellular Shade Collection GENERAL INFORMATION

Scotchgard™ and Certified Fabrics

Scotchgard Protection

Scotchgard™ Protector is available with all cellular Shades. Scotchgard™ keeps your shades looking newer, fresher and cleaner longer.



A combination of the latest advances in stain release and repellency provides exceptional stain protection. Spills wipe away easily and most dirt and stains lift out when cleaned. Both sides of the fabric are treated with Scotchgard.

GREENGUARD Certified Fabrics

GREENGUARD Indoor Air Quality Certified® Fabrics
The GREENGUARD Environmental Institute has established performance based standards to define goods with low chemical and particle emissions for use indoors.

The following fabrics have the passed GREENGUARD Indoor Air Quality Certified® certification program for low emitting interior building materials, furnishings, and finish systems:

- Symphony (All)
- Virtuoso (All)
- Baritone (All)
- Premiere (All)
- Natural Linen Flax
- Debut (All)
- **Linen Weave**

The following fabrics have the passed GREENGUARD Children & SchoolsSM product certification program for low emitting interior building materials, furnishings, and finish systems used in educational (day care and K-12) environments:

- Symphony Light Filtering
- Symphony Blackout

Cleaning and Care

While beautiful and pleasing to the eye, all Comfortex products are designed to be durable, easily cared for and easily cleaned. Our non-woven fabrics are inherently anti-static and repel dust, but occasional feather dusting or vacuuming may be necessary to keep the fabrics clean and bright. Comfortex Cellular fabrics may be ultrasonically cleaned.

Cleaning all other Comfortex Cellular Fabrics:

Our light filtering and room darkening fabrics are inherently anti-static and repel dust, but occasional cleaning may be necessary to keep the fabrics clean and bright. The fabric can be dusted with a soft, clean cloth, feather duster or lightly vacuumed with a soft brush attachment. Spills and stains can be lightly blotted with a cloth or damp sponge. More difficult stains may require soaking in water with mild soap. For this, remove the shades from the window and soak in warm water. Complete immersion of hardware is not recommended.

DO NOT submerge the Cordless Ultra head rail in water. When damp, lay flat to dry or place back in window and raise tightly to recrisp pleats. Please test any stronger cleaners on an unobtrusive portion of the shade before using.

For additional advice on care or cleaning, please contact our Technical Services Department.

Scotchgard™ Treated Shades

The following are the recommended cleaning and care instructions for window treatments with fabric treated with Scotchgard™ Protector.

- Gently blot liquid stains immediately with a clean, white cloth.
- If stain remains, prepare a solution of ¼ teaspoon of clear, non-bleaching dish detergent mixed with 1 cup of lukewarm water. Dampen a clean white cloth and gently blot the stain.
- Do not overwet the fabric or excessively rub the stained area.
- See the Installation and Care instructions for complete details.

For additional assistance with stain removal, call the Scotchgard™ Protector Service Center at 1-800-433-3296. Customer Care representatives are available Monday through Friday, 8am to 6pm CT.

Cellular Shade Collection GENERAL INFORMATION

Cellular Shade MEASURING INSTRUCTIONS

Comfortex accepts measurements down to $\frac{1}{16}$ " increments.

Inside Mount

Use a steel tape to measure the opening at three different places, and use the narrowest dimension when ordering. Be exact! The factory will make the shade $\frac{3}{16}$ " narrower so it will not rub against the window casing. Measure the height of the window from the top (soffit) down to the sill.

Outside or Ceiling Mount

Use a steel tape to measure the exact height and width of the area to be covered. It is recommended that the shades overlap the window by at least $1\frac{1}{2}$ " on each side. When installation has no sill, allow the shade to overlap the bottom of the window casing by at least $1\frac{1}{2}$ ". Shade fabric will measure width indicated on the order form.

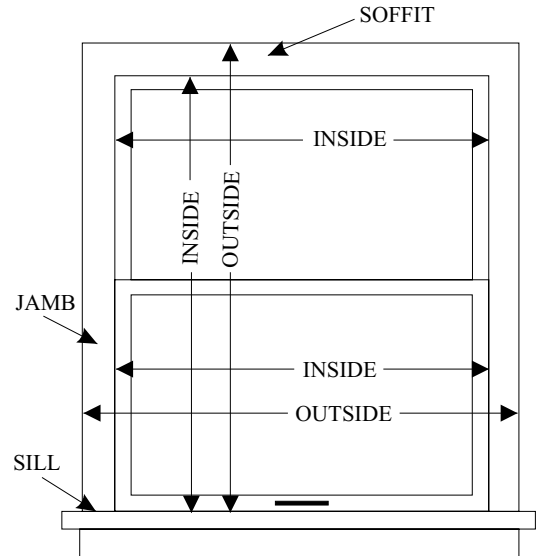

Measuring for Specialty Shapes

Templates are required with some specialty shade orders. Consult the individual product sections of this guide for specifics regarding accurate measurements and mounting information.

Arches and Quarter Round Circles

- Measure the window height and width appropriately for an inside or outside mount.
- With perfect arches, the height will be one half the width. With perfect quarter rounds, height will equal width. If the arch or quarter round is perfect, **a template is not required.**
- Windows with imperfect arch measurements do not maintain the height/width relationship. Templates **are required** for these windows.

Trapezoids

- Measure the window height and width appropriately for an inside or outside mount. For outside mounts, remember to add the desired amount of overlap.
- Measure all four sides for accurate fabrication. Provide all measurements. **Templates are not required.**
- The slope angle must be measured with a protractor. Slope is the angle between slope and a horizontal line. The maximum slope is 30 degrees.

Octagons

- Measure the window height and width appropriately for an inside or outside mount. Be sure to measure the width at the shade's widest point.
- Provide the width, length and the length of one side when ordering.

Cellular Shade Collection

GENERAL INFORMATION

Making the Perfect Template

Tape brown craft paper over the window opening. Be sure to allow plenty of overlap and check to see that the paper is smooth and pulled taut. Do not use newspaper as the ink can rub off on fabric. Do not use paper that has been folded. Notice the outline of the framework superimposed on the template as the light filters through the window. You may create the template in one of two ways:

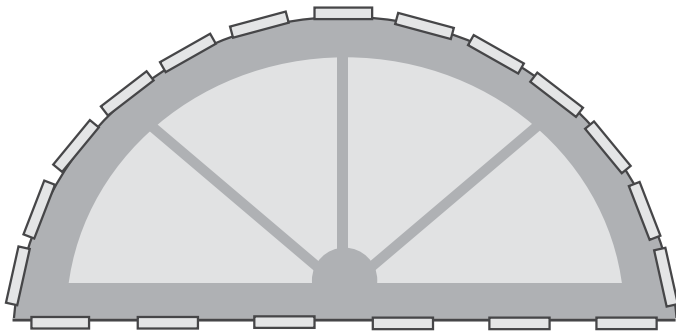

Trace the outline of the window with a pencil and continue along the side of the window frame. Once the window is completely traced, remove the craft paper from the window. Cut out the traced shape with a pair of scissors.

You may choose to skip tracing the window outline with a pencil and cut out the shape immediately with a razor knife.

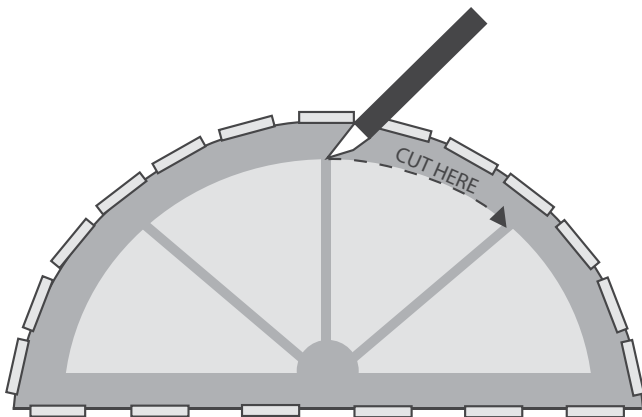

Once your template is cut, double check its width and height with your initial measurements. Test the template by placing it in the window. Check for light gaps, uneven cutting of curves etc. Trim or remake if necessary.

With arch top shades, fold the template in half. Check the outline of the curve for smoothness, light gaps and curve continuity. Place the template in the window and check it for light gaps or uneven cutting of curve. Trim or remake it if necessary.

On the front of the template, mark the shade measurements along with your company name, account number, sidemark, shade style and color. Be sure to indicate inside or outside mount, the room side and which ends of the template are top and bottom. Do not take any deductions on inside mount shades. The factory will make all necessary allowances for inside mounts.

Remember: The quality of the finished shades depends heavily on the quality of the template supplied. Do not hesitate to remake a template if you feel uncomfortable of the quality of your first attempt.

Template Kits: Comfortex offers template kits which includes brown craft paper, razor knife, instructions and order form. Please contact Customer Service or visit www.comfortex.com to order. Stock number: 751000

Cut-Outs

Cut-outs are available with all cellular fabrics.

Cut-outs are \$69.00 per side and are subject to approval by the Comfortex Technical Service department.

There are no limits on cut out lengths.

There are limits on cut out widths.

Cellular shade widths 18" or less: maximum 3" width cut-out

Cellular shade widths greater than 18": maximum 5" width cut-out

Cellular Shade Collection GENERAL INFORMATION

⚠️ WARNING

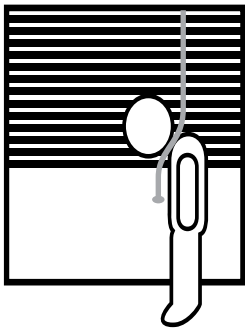

Window Blind Cord Can
STRANGLE Your Child.

To prevent strangulation, purchase
cordless products or products with
inaccessible cords.

⚠️ ADVERTENCIA

La cuerda ciega de la ventana
puede ESTRANGULAR su niño.

Para evitar el estrangulamiento,
compre alternativas inalámbricas o
productos con cables inaccesibles.

Child Safety

Comfortex has a long history of designing new child-safety products and is proud to provide a leadership role in cooperating with the Consumer Product Safety Commission (CPSC) for the development of policies and guidelines for the industry by serving on the WCMA Standards Development Committee.

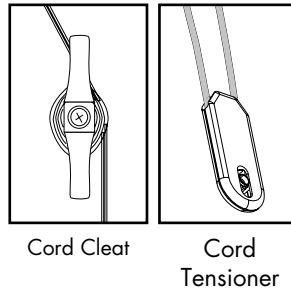

All Comfortex products have been fully tested and proven to comply with the current WCMA Standards for safety of corded window coverings.

Be aware that it is possible for children to become entangled in window covering cords. To reduce the risk of accidents, all cords must be kept out of the reach of children.

A cord cleat or cord tensioner is an effective way to implement this essential precaution. Please use them.

To mount the cord cleat at a safe height, take into account furniture or other objects upon which a child may climb. Then, after the use of the blind, simply wrap the excess cord around the cleat.

COLOR LUX CELLULAR SHADES

	Page
Hardware Options	1
Size Standards	4
Hardware Option Availability	7
Hardware Upgrade Options.	9

PRICE GRIDS

Standard Rectangular - Light Filtering	Price Group 1	11
Standard Rectangular - Room Darkening	Price Group 2	12
Boutique Standard Rectangular	Price Group 3 & 4	13
Ovation Cellular Sliders	Price Group 5 & 6	14
Boutique Ovation Cellular Sliders	Price Group 7 & 8	15
Starburst Non-Movable & Movable Arches Non-Movable & Movable Quarter Rounds	Price Group 9 & 10	16
Sunset Movable Arches	Price Group 11 & 12	17
Trapezoids and Octagons	Price Group 13 & 14	18
Mezz Motorized Skylights	Price Group 15 & 16	19
Soprano Skylights	Price Group 17 & 18	20
Balcony Skylights	Price Group 19 & 20	21
Non-Movable French Door Decor	Price Group 21 & 22	22
Movable French Door Decor.	Price Group 23 & 24	23

HARDWARE

Standard Cord Lock.	25
Cord Loop	27
Cordless Ultra	29
Cordless Lift & Lock.	31
Simplicity Bluetooth Motorization with Quietude™ Technology.	33
12V Non-Rechargeable Simplicity Motorization	34
7.4V Rechargeable Simplicity Motorization.	36
7.4V Rechargeable Motorized Top Down-Bottom Up	39
7.4V EZ Charge Extension Wand	41
12V Simplicity Low Voltage Hardwiring System	42
Simplicity Smart Controller	43
7.4V Rechargeable PowerTouch Motorized	44
Friction Fit	46

COLOR LUX CELLULAR SHADES- CONTINUED

	Page
Ovation Cellular Slider	47
Insulating Slumbershades	49
Strataview	51
Starburst Arches	53
Quarter Rounds	54
Sunset Arches	56
Trapezoids and Octagons	58
Mezzo Motorized Skylight	60
Soprano Skylight	63
Balcony Shadings	65
French Door Decor	67
Day-Night Shades	69

GENERAL INFORMATION

EZ Level	72
Cleaning and Care	73
Measuring	74
Making A Template	75
Child Safety	76



Midwest
Designer
Supply

1-888-523-2611

**Midwest Designer Supply, Inc.
N30W22377 Green Road Ste C
Waukesha, WI 53186
(262) 523-2600
Fax (262) 524-1007
www.midwestdesignersupply.com**

MDS - your one source for window fashions.